

Industriehof Scherenbostel
Heinrich Rodenbostel GmbH
Im Winkel 5
D-30900 Wedemark
Telefon +49 (0) 51 30 - 60 72 - 0
Telefax +49 (0) 51 30 - 60 72 32
Internet: www.industriehof.com
E-mail: info@industriehof.com

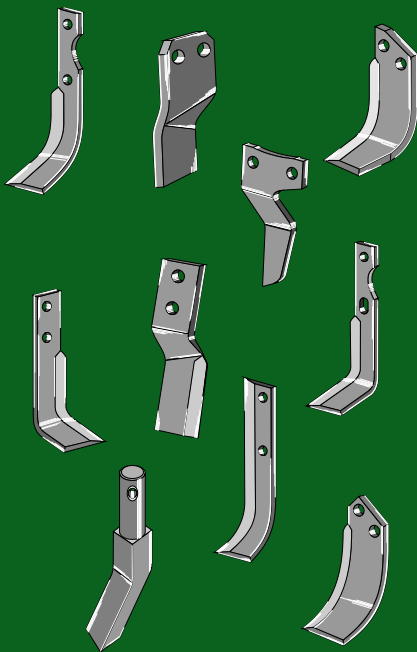

2



Alle Rechte vorbehalten
Nachdruck, auch auszugsweise, verboten

Tous droits réservés
Toute reproduction, même par extrait, défendue

All rights reserved
Reproduction in any form forbidden

© Copyright Industriehof Scherenbostel

Fräsmesser und Rotorzinken
Couteaux et lames de rotalabour
Blades and knives for spike rotor

3-68

Universal Fräsmesser
Couteaux universels
All-purpose blades

69

Schrauben für Fräsmesser und Rotorzinken
Boulons pour couteaux et lames de rotalabour
Bolts for blades and knives

70

- Keine Original-Ersatzteile - Il ne s'agit pas de pièces originales - No genuine spare parts -

Technische Änderungen vorbehalten - Modifications techniques réservées - Technical changes reserved
Maße und Gewichte annähernd und unverbindlich - Les mesures et poids sont approximatifs et sous réserve - Dimensions and weights are approximate and not binding

Fräsmesser und Rotorzinken nach Fabrikat:

Couteaux et lames de rotalabour pour machines: / Blades and knives for spike rotor to fit:

	Seite / page		Seite / page		Seite / page
Adriatica	4	Fort	30-31	Renter L.M.T.	61
Agrator	5	Gaspardo	31	Rinieri	61
Agria	5-7	Gehring	31	Rota Dairon	61
Agric	7	Goldoni	31-33	Roteco	61-62
Agricom	7	Gramegna	33	Sandri	62
Agrimac	7	Grillo (Pinza)	33-34	Sauerburger	62
Agritalia	8	Gutbrod	34	Schneider	62
Agromet	8	Hako	35	S.E.P.	62-63
Alpego	8	Holder	35	Sicma (Miglianico)	63-64
Badalini	8-9	Honda	35-36	Simon	64-65
Baiano	9	Howard	36-39	Solo	65
Barbieri	9-10	Huard	39	Sovema	65-66
Baroni	10	Iseki	39	Tielbürger	66
B.C.S	11	JNC	39-40	Tortella	66-67
Benassi	11-13	Kongskilde	40	Valpadana	67-68
Berti	13	Krone	40-41	Vigolo	68
Bertolini	13-15	Kuhn	41-43	VMC	68
Bonfiglioli	15	Kverneland	43	Yanmar	68
Braun	15	Landsberg	43	Zappator	68
Breviglieri	15-17	M.A.B. Bocchini	43-44		
Brumital-Agris	17-19	M.A.G.	44	Universal Fräsmesser	
Bungartz	19	M.Gi.Bi.	44	Couteaux universels	
Cab	19	Maletti	45-46	All-purpose blades	69
Calderoni	19	Maschio	46-49		
Carraro Antonio	19-20	Massano	49-50		
Carraro S.p.A.	20	M.E.A.A.T.	50		
Casorzo	20-21	Mearelli	50		
Celli	21-23	Meritano	51	Schrauben mit Sicherungsmuttern	
Comeb	23-24	Muratori	51-53	boulons avec écrous à freinage interne	
Del Morino	24	Nardi	53-54	bolts with self-locking nuts	
Diesse	24	Nibbi Bruno	54-55	Schrauben mit Muttern	
Dondi	24-25	Nibbi Decimo	55	und Federringe	
Dutzi	25	Niemeyer	55	boulons avec écrous	
Eberhardt	25	Ommas	55-56	et rondelles-ressort	
Eurogreen	25	Ompi	56	bolts with nuts	70
Eurosystem	25-26	Oosterlaan	56	and split washers	
Fahr	26	Ortolan	56	Sechskantmuttern	
Falc	26	P.G.S.	56	écrous hexagonaux	70
Falconero	26	Palladino	56	hexagon nuts	
Ferrari	27-28	Pabso	57	Federringe	
Ferri	28	Pasquali	57-58	rondelles élastiques	70
Ferri & Simoni	28	Pegoraro	58-59	split washers	
Fischgräbe	28	Perugini	59-60	Selbstsichernde Muttern	
FM-Matras	28-29	Rabe	60	écrous à freinage interne	70
Forigo-Roteritalia	29-30	Rau	60	self-locking nuts	

- Keine Original-Ersatzteile - Il ne s'agit pas de pièces originales - No genuine spare parts -

Maße und Gewichte annähernd und unverbindlich - Les mesures et poids sont approximatifs et sous réserve - Dimensions and weights are approximate and not binding
Technische Änderungen vorbehalten - Modifications techniques réservées - Technical changes reserved

links
gauche / left

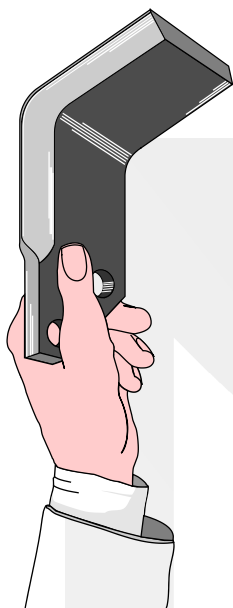

rechts
droit / right

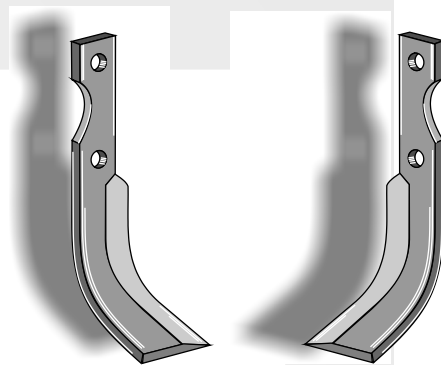
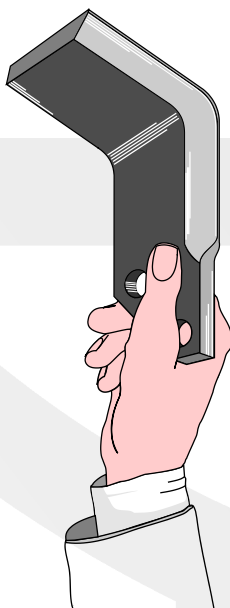

links
gauche / left

rechts
droit / right

Der Bogen muss auf Sie zuzeigen.

La courbure doit pointer sur vous.

The bow must point at you.

Die Abbildungen im Katalog sind **RECHTE AUSFÜHRUNGEN.**

Les figures dans le catalogue sont les modèles droits.

The pictures in the catalogue are the right models.

Die angebotenen Artikel sind Qualitätserzeugnisse mit Garantie, passend zu den entsprechenden Maschinenfabrikaten. (Keine Original Ersatzteile) Die Original-Nummern dienen nur der Zuordnung. Alle angegebenen Abmessungen und Ausführungen entsprechen den z.Zt. gültigen Anforderungen. Wir behalten uns das Recht auf Abweichungen, bedingt durch Werkzeug- oder Anforderungsänderungen, vor.

Les articles présentés sont des produits de qualité garantie s'accordant aux machines correspondantes.
(aucune pièce de rechange originale) Les références d'origines ne servent qu'à la coordination.

Les exécutions et les dimensions satisfont aux exigences actuelles.

Nous nous réservons le droit de toute modification dûe aux changements d'exigences ou d'outils.

The showed parts are guaranteed quality products, fitting the equivalent machines.(no original spare parts)

The original part-numbers are only indicated for coordination.

The showed dimensions and designs are in accordance with the actual requests.

Every modification caused by changes of requirements or tools are subject to alterations.

Muzzi-Fräsmesser werden ausschließlich aus Borstahl hergestellt und auf 46 +/- 3 HRC gehärtet. Gekennzeichnet werden die Messer mit einem eingepprägten Adler.

Les couteaux Muzzi sont fabriqués exclusivement en acier au bore et trempés à 46 +/- 3 HRC.
Ils sont marqués d'un aigle.

Muzzi-blades are exclusively made of boron steel and hardened on 46 +/- 3 HRC.
They are marked with an eagle.



Original Muzzi-Fräsmesser mit Garantie / couteaux Muzzi avec garantie / Original warranted Muzzi Blades

Adriatica

ADR-01R re/dr/ri	
ADR-01L li/ga/le	
Orig.-Nr. / réf. origine / orig.-part-no.	
HP8-10	
Gewicht / poids / weight	0,780
Schraube M12x1,25x35 - 12.9 boulon / bolt	30-1235

Adriatica

ADR-04R re/dr/ri	
ADR-04L li/ga/le	
Orig.-Nr. / réf. origine / orig.-part-no.	
HP8-10	
Gewicht / poids / weight	0,340
Schraube M8x1x30 - 10.9 boulon / bolt	30-830

Adriatica

ADR-05R re/dr/ri	
ADR-05L li/ga/le	
Orig.-Nr. / réf. origine / orig.-part-no.	
HP12-14-16	
Gewicht / poids / weight	0,370
Schraube M10x1x30 - 10.9 boulon / bolt	30-1030

Adriatica

ADR-06R re/dr/ri	
ADR-06L li/ga/le	
Orig.-Nr. / réf. origine / orig.-part-no.	
HP15-18	
Gewicht / poids / weight	0,480
Schraube M10x1x30 - 10.9 boulon / bolt	30-1030

Adriatica

ADR-07R re/dr/ri	
ADR-07L li/ga/le	
Orig.-Nr. / réf. origine / orig.-part-no.	
HP10-14	
Gewicht / poids / weight	0,480
Schraube M10x1x35 - 10.9 boulon / bolt	30-1035

Adriatica

ADR-09R re/dr/ri	
ADR-09L li/ga/le	
Orig.-Nr. / réf. origine / orig.-part-no.	
HP10-14	
Gewicht / poids / weight	0,370
Schraube M8x1x30 - 10.9 boulon / bolt	30-830

Adriatica

ADR-10R re/dr/ri	
ADR-10L li/ga/le	
Orig.-Nr. / réf. origine / orig.-part-no.	
HP10-14	
Gewicht / poids / weight	0,440
Schraube M10x1x35 - 10.9 boulon / bolt	30-1035

Adriatica

ADR-11R re/dr/ri	
ADR-11L li/ga/le	
Orig.-Nr. / réf. origine / orig.-part-no.	
HP15-18	
Gewicht / poids / weight	0,420
Schraube M10x1x30 - 10.9 boulon / bolt	30-1030

Adriatica

ADR-12R re/dr/ri	
ADR-12L li/ga/le	
Orig.-Nr. / réf. origine / orig.-part-no.	
HP8-10	
Gewicht / poids / weight	0,160
Schraube M8x1x30 - 10.9 boulon / bolt	30-830

Adriatica

FOR-02R re/dr/ri	
FOR-02L li/ga/le	
Orig.-Nr. / réf. origine / orig.-part-no.	
Pantera HP 8-10	
Gewicht / poids / weight	0,340
Schraube M8x1x30 - 10.9 boulon / bolt	30-830

- Keine Original-Ersatzteile - Il ne s'agit pas de pièces originales - No genuine spare parts -

Maße und Gewichte annähernd und unverbindlich - Les mesures et poids sont approximatifs et sous réserve - Dimensions and weights are approximate and not binding - Technische Änderungen vorbehalten - Modifications techniques réservées - Technical changes reserved



Original Muzzi-Fräsmesser mit Garantie / couteaux Muzzi avec garantie / Original warranted Muzzi Blades

Fräsmesser u. Rotorzinken nach Fabrikat:
 Couteaux et lames de rotalabour pour machines:
 Blades and knives for spike rotor to fit:

Technische Änderungen vorbehalten - Modifications techniques réservées - Technical changes reserved
 Maße und Gewichte annähernd und unverbindlich - Les mesures et poids sont approximatifs et sous réserve - Dimensions and weights are approximate and not binding

Agrator	
AGRA-05R re/dr/ri	
AGRA-05L li/ga/le	
NEU	
Orig.-Nr. / réf. origine / orig.-part-no.	
Gewicht / poids / weight 0,840	
Schraube 7/16"UNFx32 - 12.9 boulon / bolt	30-71632

Agrator	
AGRA-07R re/dr/ri	
AGRA-07L li/ga/le	
NEU	
Orig.-Nr. / réf. origine / orig.-part-no.	
Gewicht / poids / weight 1,130	
Schraube 1/2"UNFx38 - 12.9 boulon / bolt	30-3903

Agrator	
AGRI-03R re/dr/ri	
AGRI-03L li/ga/le	
NEU	
Orig.-Nr. / réf. origine / orig.-part-no.	
Gewicht / poids / weight 0,670	
Schraube 7/16"UNFx32 - 12.9 boulon / bolt	30-71632

Agria	
AGR-02R re/dr/ri	
AGR-02L li/ga/le	
Orig.-Nr. / réf. origine / orig.-part-no.	
125027130 re/dr/ri	
125027129 li/ga/le	
Gewicht / poids / weight 0,160	
Schraube M8x1x30 - 10.9 boulon / bolt	30-830

Agria	
AGR-03R re/dr/ri	
AGR-03L li/ga/le	
Orig.-Nr. / réf. origine / orig.-part-no.	
06039 re/dr/ri	
06038 li/ga/le	
Gewicht / poids / weight 0,820	
Schraube M10x1x30 - 10.9 boulon / bolt	30-1030

Agria	
AGR-04R re/dr/ri	
AGR-04L li/ga/le	
Orig.-Nr. / réf. origine / orig.-part-no.	
125025498 re/dr/ri	
125025497 li/ga/le	
Gewicht / poids / weight 0,190	
Schraube M8x1x30 - 10.9 boulon / bolt	30-830

Agria	
AGR-05R re/dr/ri	
AGR-05L li/ga/le	
Orig.-Nr. / réf. origine / orig.-part-no.	
NH17549 re/dr/ri	
NH17548 li/ga/le	
Gewicht / poids / weight 0,180	
Schraube M8x1x30 - 10.9 boulon / bolt	30-830

Agria	
AGR-06R re/dr/ri	
AGR-06L li/ga/le	
Orig.-Nr. / réf. origine / orig.-part-no.	
125021099 re/dr/ri	
125021098 li/ga/le	
Gewicht / poids / weight 0,200	
Schraube M8x1x30 - 10.9 boulon / bolt	30-830

Agria	
AGR-08	
Orig.-Nr. / réf. origine / orig.-part-no.	
06622/1567	
Gewicht / poids / weight 0,170	

Agria	
AGR-09R re/dr/ri	
AGR-09L li/ga/le	
Orig.-Nr. / réf. origine / orig.-part-no.	
15454 re/dr/ri	
15453 li/ga/le	
Gewicht / poids / weight 0,650	
Schraube M10x1x35 - 10.9 boulon / bolt	30-1035

Agria	
AGR-11R re/dr/ri	
AGR-11L li/ga/le	
Orig.-Nr. / réf. origine / orig.-part-no.	
NH16549 re/dr/ri	
NH16548 li/ga/le	
Gewicht / poids / weight 0,170	
Schraube M8x1x30 - 10.9 boulon / bolt	30-830



Original Muzzi-Fräsmesser mit Garantie / couteaux Muzzi avec garantie / Original warranted Muzzi Blades

- Keine Original-Ersatzteile - Il ne s'agit pas de pièces originales - No genuine spare parts -

Agria	
AGR-12R re/dr/ri	
AGR-12L li/ga/le	
Orig.-Nr. / réf. origine / orig.-part-no.	
Typ 6000	
Gewicht / poids / weight	0,380
Schraube M8x1x30 - 10.9 boulon / bolt	30-830

Agria	
AGR-13R re/dr/ri	
AGR-13L li/ga/le	
Orig.-Nr. / réf. origine / orig.-part-no.	
125017223 re/dr/ri	
125017222 li/ga/le	
Gewicht / poids / weight	0,220
Schraube M8x1x30 - 10.9 boulon / bolt	30-830

Agria	
AGR-15R re/dr/ri	
AGR-15L li/ga/le	
Orig.-Nr. / réf. origine / orig.-part-no.	
1767-12868 re/dr/ri	
1767-12869 li/ga/le	
Gewicht / poids / weight	0,350
Schraube M10x1x30 - 10.9 boulon / bolt	30-1030

Agria	
AGR-18R re/dr/ri	
AGR-18L li/ga/le	
Orig.-Nr. / réf. origine / orig.-part-no.	
1667-06624 re/dr/ri	
1667-06623 li/ga/le	
Gewicht / poids / weight	0,180
Schraube M10x1x35 - 10.9 boulon / bolt	30-1035

Agria	
AGR-19R re/dr/ri	
AGR-19L li/ga/le	
Orig.-Nr. / réf. origine / orig.-part-no.	
616112 re/dr/ri	
616113 li/ga/le	
Gewicht / poids / weight	0,190
Schraube M8x1x30 - 10.9 boulon / bolt	30-830

Agria	
AGR-20R re/dr/ri	
AGR-20L li/ga/le	
Orig.-Nr. / réf. origine / orig.-part-no.	
616112 re/dr/ri	
616113 li/ga/le	
Gewicht / poids / weight	0,195
Schraube M8x1x30 - 10.9 boulon / bolt	30-830

Agria	
AGR-22R re/dr/ri	
AGR-22L li/ga/le	
Orig.-Nr. / réf. origine / orig.-part-no.	
70234 re/dr/ri	
70233 li/ga/le	
Gewicht / poids / weight	0,500
Schraube M8x1x30 - 10.9 boulon / bolt	30-830

Agria	
AGR-23R re/dr/ri	
AGR-23L li/ga/le	
Orig.-Nr. / réf. origine / orig.-part-no.	
616112 re/dr/ri	
616113 li/ga/le	
Gewicht / poids / weight	0,125
Schraube M8x1x30 - 10.9 boulon / bolt	30-830

Agria	
AGR-57R re/dr/ri	
AGR-57L li/ga/le	
Orig.-Nr. / réf. origine / orig.-part-no.	
1667	
Gewicht / poids / weight	0,220
Schraube M8x1x30 - 10.9 boulon / bolt	30-830

Agria	
AGR-59R re/dr/ri	
AGR-59L li/ga/le	
Orig.-Nr. / réf. origine / orig.-part-no.	
1667	
Gewicht / poids / weight	0,180
Schraube M8x1x30 - 10.9 boulon / bolt	30-830

- Keine Original-Ersatzteile - Il ne s'agit pas de pièces originales - No genuine spare parts -

Maße und Gewichte annähernd und unverbindlich - Les mesures et poids sont approximatifs et sous réserve - Dimensions and weights are approximate and not binding - Technische Änderungen vorbehalten - Modifications techniques réservées - Technical changes reserved



Original Muzzi-Fräsmesser mit Garantie / couteaux Muzzi avec garantie / Original warranted Muzzi Blades

Fräsmesser u. Rotorzinken nach Fabrikat:
 Couteaux et lames de rotalabour pour machines:
 Blades and knives for spike rotor to fit:

Technische Änderungen vorbehalten - Modifications techniques réservées - Technical changes reserved
 Maße und Gewichte annähernd und unverbindlich - Les mesures et poids sont approximatifs et sous réserve - Dimensions and weights are approximate and not binding

Agria	
AGR-60R re/dr/ri	
AGR-60L li/ga/le	
Orig.-Nr. / réf. origine / orig.-part-no.	
1767 (071943) re/dr/ri	
1767 (071953) li/ga/le	
Gewicht / poids / weight	0,200
Schraube M8x1x30 - 10.9 boulon / bolt	30-830

Agria	
BCS-01R re/dr/ri	
BCS-01L li/ga/le	
Orig.-Nr. / réf. origine / orig.-part-no.	
69726 re/dr/ri	
69725 li/ga/le	
Gewicht / poids / weight	0,200
Schraube M8x1x30 - 10.9 boulon / bolt	30-830

Agria	
BEN-51R re/dr/ri	
BEN-51L li/ga/le	
Orig.-Nr. / réf. origine / orig.-part-no.	
Gewicht / poids / weight	
0,300	
Schraube M8x1x30 - 10.9 boulon / bolt	30-830

Agric	
AGRA-07R re/dr/ri	
AGRA-07L li/ga/le	
Orig.-Nr. / réf. origine / orig.-part-no.	
Gewicht / poids / weight	
1,130	
Schraube 1/2"UNFx38 - 12.9 boulon / bolt	30-3903

Agric	
AGRI-01R re/dr/ri	
AGRI-01L li/ga/le	
Orig.-Nr. / réf. origine / orig.-part-no.	
Gewicht / poids / weight	
0,850	
Schraube 7/16"UNFx32 - 12.9 boulon / bolt	30-71632

Agric	
AGRI-03R re/dr/ri	
AGRI-03L li/ga/le	
Orig.-Nr. / réf. origine / orig.-part-no.	
Gewicht / poids / weight	
0,670	
Schraube 7/16"UNFx32 - 12.9 boulon / bolt	30-71632

Agric	
AGRI-04R re/dr/ri	
AGRI-04L li/ga/le	
Orig.-Nr. / réf. origine / orig.-part-no.	
Gewicht / poids / weight	
1,250	

Agricom	
HOW-03R re/dr/ri	
HOW-03L li/ga/le	
Orig.-Nr. / réf. origine / orig.-part-no.	
Gewicht / poids / weight	
1,000	

Agricom	
HOW-04R re/dr/ri	
HOW-04L li/ga/le	
Orig.-Nr. / réf. origine / orig.-part-no.	
Gewicht / poids / weight	
0,850	

Agrimac	
AGI-01R re/dr/ri	
AGI-01L li/ga/le	
Orig.-Nr. / réf. origine / orig.-part-no.	
Gewicht / poids / weight	
0,400	
Schraube M10x1x35 - 10.9 boulon / bolt	30-1035



Original Muzzi-Fräsmesser mit Garantie / couteaux Muzzi avec garantie / Original warranted Muzzi Blades

- Keine Original-Ersatzteile - Il ne s'agit pas de pièces originales - No genuine spare parts

Agritalia

CRR-01R re/dr/ri	
CRR-01L li/ga/le	
Orig.-Nr. / réf. origine / orig.-part-no.	
Gewicht / poids / weight 1,000	
Schraube M12x1,25x35 - 12.9 boulon / bolt	30-1235

Agritalia

CRR-02R re/dr/ri	
CRR-02L li/ga/le	
Orig.-Nr. / réf. origine / orig.-part-no.	
Gewicht / poids / weight 1,000	
Schraube M12x1,25x35 - 12.9 boulon / bolt	30-1235

Agritalia

CRR-03R re/dr/ri	
CRR-03L li/ga/le	
Orig.-Nr. / réf. origine / orig.-part-no.	
Gewicht / poids / weight 0,600	
Schraube M12x1,25x35 - 12.9 boulon / bolt	30-1235

Agromet

POL-02R re/dr/ri	
POL-02L li/ga/le	
Orig.-Nr. / réf. origine / orig.-part-no.	
150020020 re/dr/ri	
150002001 li/ga/le	
Gewicht / poids / weight 0,700	
Schraube M16x1,5x47 - 12.9 boulon / bolt	30-1647

Alpego

ALP-01R re/dr/ri	
ALP-01L li/ga/le	
Orig.-Nr. / réf. origine / orig.-part-no.	
Gewicht / poids / weight 1,400	

Alpego

ALP-02R re/dr/ri	
ALP-02L li/ga/le	
Orig.-Nr. / réf. origine / orig.-part-no.	
Gewicht / poids / weight 1,830	

Badalini

BAD-01R re/dr/ri	
BAD-01L li/ga/le	
Orig.-Nr. / réf. origine / orig.-part-no.	
F/777	
Gewicht / poids / weight 0,360	
Schraube M10x1x30 - 10.9 boulon / bolt	30-1030

Badalini

BAD-03R re/dr/ri	
BAD-03L li/ga/le	
Orig.-Nr. / réf. origine / orig.-part-no.	
3226	
Gewicht / poids / weight 0,820	
Schraube M12x1,25x35 - 12.9 boulon / bolt	30-1235

Badalini

BAD-05R re/dr/ri	
BAD-05L li/ga/le	
Orig.-Nr. / réf. origine / orig.-part-no.	
MA5034	
Gewicht / poids / weight 0,300	
Schraube M10x1x30 - 10.9 boulon / bolt	30-1030

Badalini

BAD-13R re/dr/ri	
BAD-13L li/ga/le	
Orig.-Nr. / réf. origine / orig.-part-no.	
FM6401	
Gewicht / poids / weight 1,000	

- Keine Original-Ersatzteile - Il ne s'agit pas de pièces originales - No genuine spare parts -

Maße und Gewichte annähernd und unverbindlich - Les mesures et poids sont approximatifs et sous réserve - Dimensions and weights are approximate and not binding - Technische Änderungen vorbehalten - Modifications techniques réservées - Technical changes reserved



Original Muzzi-Fräsmesser mit Garantie / couteaux Muzzi avec garantie / Original warranted Muzzi Blades

Fräsmesser u. Rotorzinken nach Fabrikat:
 Couteaux et lames de rotalabour pour machines:
 Blades and knives for spike rotor to fit:

Technische Änderungen vorbehalten - Modifications techniques réservées - Technical changes reserved
 Maße und Gewichte annähernd und unverbindlich - Les mesures et poids sont approximatifs et sous réserve - Dimensions and weights are approximate and not binding

Badalini BAD-25R re/dr/ri BAD-25L li/ga/le 		Badalini BAD-30R re/dr/ri BAD-30L li/ga/le 		Badalini BAD-35R re/dr/ri BAD-35L li/ga/le 		Badalini BAD-36R re/dr/ri BAD-36L li/ga/le 	
Orig.-Nr. / réf. origine / orig.-part-no.		Orig.-Nr. / réf. origine / orig.-part-no.		Orig.-Nr. / réf. origine / orig.-part-no.		Orig.-Nr. / réf. origine / orig.-part-no.	
		FM6401A		8914		MR-MS777B	
Gewicht / poids / weight		Gewicht / poids / weight		Gewicht / poids / weight		Gewicht / poids / weight	
0,350		1,100		0,510		0,400	
Schraube M10x1x30 - 10.9 boulon / bolt		Schraube M10x1x30 - 10.9 boulon / bolt		Schraube M12x1,25x35 - 12.9 boulon / bolt		Schraube M10x1x30 - 10.9 boulon / bolt	
30-1030		30-1030		30-1235		30-1030	
Badalini BAD-40R re/dr/ri BAD-40L li/ga/le 		Baiano BAI-04L li/ga/le 		Barbieri BAR-01R re/dr/ri BAR-01L li/ga/le 		Barbieri BAR-04R re/dr/ri BAR-04L li/ga/le 	
Orig.-Nr. / réf. origine / orig.-part-no.		Orig.-Nr. / réf. origine / orig.-part-no.		Orig.-Nr. / réf. origine / orig.-part-no.		Orig.-Nr. / réf. origine / orig.-part-no.	
MD-ME5145		Q110L130					
Gewicht / poids / weight		Gewicht / poids / weight		Gewicht / poids / weight		Gewicht / poids / weight	
0,390		0,450		0,380		0,470	
Schraube M10x1x30 - 10.9 boulon / bolt		Schraube M10x1x30 - 10.9 boulon / bolt		Schraube M10x1x35 - 10.9 boulon / bolt		Schraube M10x1x35 - 10.9 boulon / bolt	
30-1030		30-1030		30-1035		30-1035	
Barbieri BAR-05R re/dr/ri BAR-05L li/ga/le 		Barbieri BAR-08R re/dr/ri BAR-08L li/ga/le 		Barbieri BAR-17R re/dr/ri BAR-17L li/ga/le 			
Orig.-Nr. / réf. origine / orig.-part-no.		Orig.-Nr. / réf. origine / orig.-part-no.		Orig.-Nr. / réf. origine / orig.-part-no.			
Gewicht / poids / weight		Gewicht / poids / weight		Gewicht / poids / weight			
0,220		0,380		0,400			
Schraube M8x1x30 - 10.9 boulon / bolt		Schraube M10x1x35 - 10.9 boulon / bolt		Schraube M10x1x35 - 10.9 boulon / bolt			
30-830		30-1035		30-1035			



Original Muzzi-Fräsmesser mit Garantie / couteaux Muzzi avec garantie / Original warranted Muzzi Blades

- Keine Original-Ersatzteile - Il ne s'agit pas de pièces originales - No genuine spare parts -

Barbieri

BAR-20R re/dr/ri	
BAR-20L li/ga/le	
Orig.-Nr. / réf. origine / orig.-part-no.	
Gewicht / poids / weight 0,260	
Schraube M8x1x30 - 10.9 boulon / bolt	30-830

Barbieri

BAR-21R re/dr/ri	
BAR-21L li/ga/le	
Orig.-Nr. / réf. origine / orig.-part-no.	
Gewicht / poids / weight 0,270	
Schraube M8x1x30 - 10.9 boulon / bolt	30-830

Barbieri

BAR-24R re/dr/ri	
BAR-24L li/ga/le	
Orig.-Nr. / réf. origine / orig.-part-no.	
Gewicht / poids / weight 0,580	
Schraube M10x1x35 - 10.9 boulon / bolt	30-1035

Barbieri

BAR-33R re/dr/ri	
BAR-33L li/ga/le	
Orig.-Nr. / réf. origine / orig.-part-no.	
Gewicht / poids / weight 0,310	
Schraube M10x1x35 - 10.9 boulon / bolt	30-1035

Barbieri

BEN-11R re/dr/ri	
BEN-11L li/ga/le	
Orig.-Nr. / réf. origine / orig.-part-no.	
Gewicht / poids / weight 0,260	
Schraube M8x1x30 - 10.9 boulon / bolt	30-830

Barbieri

BEN-32R re/dr/ri	
BEN-32L li/ga/le	
Orig.-Nr. / réf. origine / orig.-part-no.	
Gewicht / poids / weight 0,330	
Schraube M8x1x30 - 10.9 boulon / bolt	30-830

Barbieri

FOR-10R re/dr/ri	
FOR-10L li/ga/le	
Orig.-Nr. / réf. origine / orig.-part-no.	
Gewicht / poids / weight 0,380	
Schraube M10x1x30 - 10.9 boulon / bolt	30-1030

Barbieri

GOL-17R re/dr/ri	
GOL-17L li/ga/le	
Orig.-Nr. / réf. origine / orig.-part-no.	
Gewicht / poids / weight 0,380	
Schraube M10x1x30 - 10.9 boulon / bolt	30-1030

Barbieri

GOL-29R re/dr/ri	
GOL-29L li/ga/le	
Orig.-Nr. / réf. origine / orig.-part-no.	
Gewicht / poids / weight 0,610	
Schraube M10x1x30 - 10.9 boulon / bolt	30-1030

Barbieri

GOL-30R re/dr/ri	
GOL-30L li/ga/le	
Orig.-Nr. / réf. origine / orig.-part-no.	
Gewicht / poids / weight 0,380	
Schraube M10x1x30 - 10.9 boulon / bolt	30-1030

Baroni

BAO-02R re/dr/ri	
BAO-02L li/ga/le	
Orig.-Nr. / réf. origine / orig.-part-no.	
Gewicht / poids / weight 0,700	
Schraube M14x1,5x40 - 12.9 boulon / bolt	30-1440

- Keine Original-Ersatzteile - Il ne s'agit pas de pièces originales - No genuine spare parts -

Maße und Gewichte annähernd und unverbindlich - Les mesures et poids sont approximatifs et sous réserve - Dimensions and weights are approximate and not binding - Technische Änderungen vorbehalten - Modifications techniques réservées - Technical changes reserved



Original Muzzi-Fräsmesser mit Garantie / couteaux Muzzi avec garantie / Original warranted Muzzi Blades

Fräsmesser u. Rotorzinken nach Fabrikat:
 Couteaux et lames de rotalabour pour machines:
 Blades and knives for spike rotor to fit:

Technische Änderungen vorbehalten - Modifications techniques réservées - Technical changes reserved
 Maße und Gewichte annähernd und unverbindlich - Les mesures et poids sont approximatifs et sous réserve - Dimensions and weights are approximate and not binding

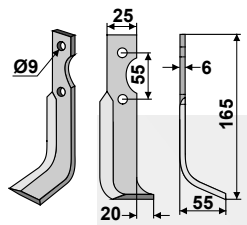
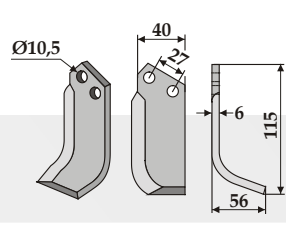
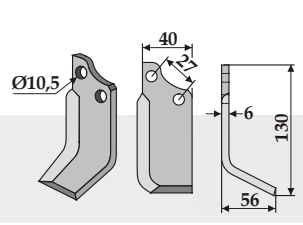
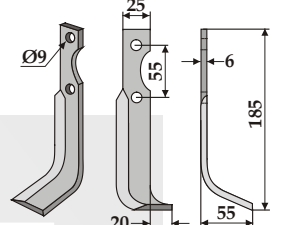
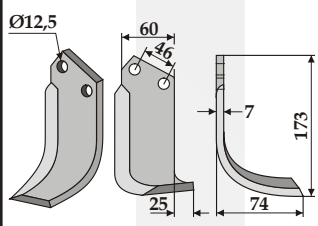
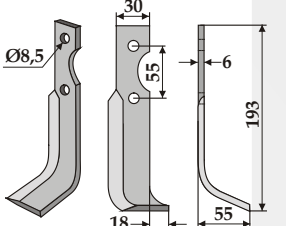
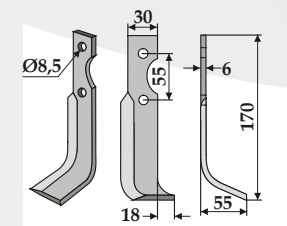
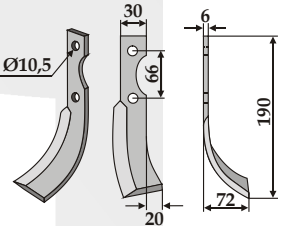
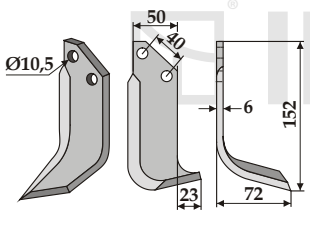
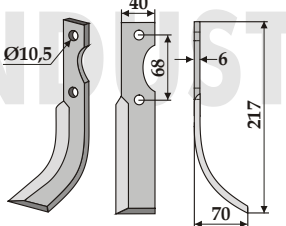
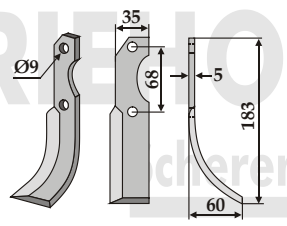
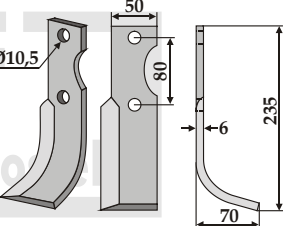
B.C.S. BCS-01R re/dr/ri BCS-01L li/ga/le  Orig.-Nr. / réf. origine / orig.-part-no. 43432 re/dr/ri 43431 li/ga/le Gewicht / poids / weight 0,200 Schraube M8x1x30 - 10.9 30-830 boulon / bolt	B.C.S. BCS-04R re/dr/ri BCS-04L li/ga/le  Orig.-Nr. / réf. origine / orig.-part-no. 48426 re/dr/ri 48425 li/ga/le Gewicht / poids / weight 0,280 Schraube M10x1x30 - 10.9 30-1030 boulon / bolt	B.C.S. BCS-06R re/dr/ri BCS-06L li/ga/le  Orig.-Nr. / réf. origine / orig.-part-no. 48434 re/dr/ri 48433 li/ga/le Gewicht / poids / weight 0,310 Schraube M10x1x30 - 10.9 30-1030 boulon / bolt	B.C.S. BCS-07R re/dr/ri BCS-07L li/ga/le  Orig.-Nr. / réf. origine / orig.-part-no. 43434 re/dr/ri 43433 li/ga/le Gewicht / poids / weight 0,240 Schraube M8x1x30 - 10.9 30-830 boulon / bolt
B.C.S. BCS-10R re/dr/ri BCS-10L li/ga/le  Orig.-Nr. / réf. origine / orig.-part-no. Gewicht / poids / weight 0,650 Schraube M8x1x30 - 10.9 30-830 boulon / bolt	B.C.S. BCS-13R re/dr/ri BCS-13L li/ga/le  Orig.-Nr. / réf. origine / orig.-part-no. Gewicht / poids / weight 0,270 Schraube M8x1x30 - 10.9 30-830 boulon / bolt	B.C.S. BCS-14R re/dr/ri BCS-14L li/ga/le  Orig.-Nr. / réf. origine / orig.-part-no. Gewicht / poids / weight 0,250 Schraube M8x1x30 - 10.9 30-830 boulon / bolt	B.C.S. GRI-01R re/dr/ri GRI-01L li/ga/le  Orig.-Nr. / réf. origine / orig.-part-no. 7085 Gewicht / poids / weight 0,290 Schraube M8x1x35 - 10.9 30-1035 boulon / bolt
B.C.S. GRI-06R re/dr/ri GRI-06L li/ga/le  Orig.-Nr. / réf. origine / orig.-part-no. 42305 re/dr/ri 42304 li/ga/le Gewicht / poids / weight 0,370 Schraube M10x1x30 - 10.9 30-1030 boulon / bolt	Benassi BEN-04R re/dr/ri BEN-04L li/ga/le  Orig.-Nr. / réf. origine / orig.-part-no. S.308 Gewicht / poids / weight 0,450 Schraube M10x1x35 - 10.9 30-1035 boulon / bolt	Benassi BEN-11R re/dr/ri BEN-11L li/ga/le  Orig.-Nr. / réf. origine / orig.-part-no. RL50/12BL55BL60S.520 Gewicht / poids / weight 0,260 Schraube M8x1x30 - 10.9 30-830 boulon / bolt	Benassi BEN-16R re/dr/ri BEN-16L li/ga/le  Orig.-Nr. / réf. origine / orig.-part-no. RL95/12(12-7) Gewicht / poids / weight 0,560 Schraube M10x1x35 - 10.9 30-1035 boulon / bolt

- Keine Original-Ersatzteile - Il ne s'agit pas de pièces originales - No genuine spare parts -



Original Muzzi-Fräsmesser mit Garantie / couteaux Muzzi avec garantie / Original warranted Muzzi Blades

Benassi

BEN-17R re/dr/ri	
BEN-17L li/ga/le	
Orig.-Nr. / réf. origine / orig.-part-no.	
RT10-12/BN9-10	
Gewicht / poids / weight	0,200
Schraube M8x1x30 - 10.9 boulon / bolt	30-830

Benassi

BEN-21R re/dr/ri	
BEN-21L li/ga/le	
Orig.-Nr. / réf. origine / orig.-part-no.	
RT8/AN7-8	
Gewicht / poids / weight	0,220
Schraube M8x1x30 - 10.9 boulon / bolt	30-830

Benassi

BEN-26R re/dr/ri	
BEN-26L li/ga/le	
Orig.-Nr. / réf. origine / orig.-part-no.	
RL303	
Gewicht / poids / weight	0,340
Schraube M10x1x35 - 10.9 boulon / bolt	30-1035

Benassi

BEN-27R re/dr/ri	
BEN-27L li/ga/le	
Orig.-Nr. / réf. origine / orig.-part-no.	
RL303-304	
Gewicht / poids / weight	0,370
Schraube M10x1x35 - 10.9 boulon / bolt	30-1035

Benassi

BEN-29R re/dr/ri	
BEN-29L li/ga/le	
Orig.-Nr. / réf. origine / orig.-part-no.	
RT45-401	
Gewicht / poids / weight	0,180
Schraube M8x1x30 - 10.9 boulon / bolt	30-830

Benassi

BEN-30R re/dr/ri	
BEN-30L li/ga/le	
Orig.-Nr. / réf. origine / orig.-part-no.	
S.300(18-6)	
Gewicht / poids / weight	0,470
Schraube M10x1x35 - 10.9 boulon / bolt	30-1035

Benassi

BEN-31R re/dr/ri	
BEN-31L li/ga/le	
Orig.-Nr. / réf. origine / orig.-part-no.	
S.300(18-7)	
Gewicht / poids / weight	0,500
Schraube M10x1x35 - 10.9 boulon / bolt	30-1035

Benassi

BEN-32R re/dr/ri	
BEN-32L li/ga/le	
Orig.-Nr. / réf. origine / orig.-part-no.	
Z3	
Gewicht / poids / weight	0,330
Schraube M8x1x30 - 10.9 boulon / bolt	30-830

Benassi

BEN-33R re/dr/ri	
BEN-33L li/ga/le	
Orig.-Nr. / réf. origine / orig.-part-no.	
Z4	
Gewicht / poids / weight	0,330
Schraube M8x1x30 - 10.9 boulon / bolt	30-830

Benassi

BEN-34R re/dr/ri	
BEN-34L li/ga/le	
Orig.-Nr. / réf. origine / orig.-part-no.	
S.300H.70	
Gewicht / poids / weight	0,490
Schraube M10x1x35 - 10.9 boulon / bolt	30-1035

Benassi

BEN-35R re/dr/ri	
BEN-35L li/ga/le	
Orig.-Nr. / réf. origine / orig.-part-no.	
RL95/12(12-8)	
Gewicht / poids / weight	0,560
Schraube M10x1x35 - 10.9 boulon / bolt	30-1035

- Keine Original-Ersatzteile - Il ne s'agit pas de pièces originales - No genuine spare parts -

Maße und Gewichte annähernd und unverbindlich - Les mesures et poids sont approximatifs et sous réserve - Dimensions and weights are approximate and not binding - Technische Änderungen vorbehalten - Modifications techniques réservées - Technical changes reserved



Original Muzzi-Fräsmesser mit Garantie / couteaux Muzzi avec garantie / Original warranted Muzzi Blades

Fräsmesser u. Rotorzinken nach Fabrikat:
 Couteaux et lames de rotalabour pour machines:
 Blades and knives for spike rotor to fit:

Technische Änderungen vorbehalten - Modifications techniques réservées - Technical changes reserved
 Maße und Gewichte annähernd und unverbindlich - Les mesures et poids sont approximatifs et sous réserve - Dimensions and weights are approximate and not binding

Benassi BEN-40R re/dr/ri BEN-40L li/ga/le		Benassi BEN-43R re/dr/ri BEN-43L li/ga/le		Benassi BEN-48R re/dr/ri BEN-48L li/ga/le		Benassi BEN-51R re/dr/ri BEN-51L li/ga/le	
Orig.-Nr. / réf. origine / orig.-part-no.		Orig.-Nr. / réf. origine / orig.-part-no.		Orig.-Nr. / réf. origine / orig.-part-no.		Orig.-Nr. / réf. origine / orig.-part-no.	
S.308		BL30		RL319			
Gewicht / poids / weight		Gewicht / poids / weight		Gewicht / poids / weight		Gewicht / poids / weight	
0,470		0,180		0,340		0,300	
Schraube M10x1x35 - 10.9 boulon / bolt		Schraube M8x1x30 - 10.9 boulon / bolt		Schraube M10x1x35 - 10.9 boulon / bolt		Schraube M8x1x30 - 10.9 boulon / bolt	
30-1035		30-830		30-1035		30-830	

Benassi BEN-52R re/dr/ri BEN-52L li/ga/le		Benassi BEN-62R re/dr/ri BEN-62L li/ga/le		Benassi SEP-20R re/dr/ri SEP-20L li/ga/le	
Orig.-Nr. / réf. origine / orig.-part-no.		Orig.-Nr. / réf. origine / orig.-part-no.		Orig.-Nr. / réf. origine / orig.-part-no.	
				BL90	
Gewicht / poids / weight		Gewicht / poids / weight		Gewicht / poids / weight	
0,350		0,200		0,330	
Schraube M10x1x35 - 10.9 boulon / bolt		Schraube M8x1x30 - 10.9 boulon / bolt		Schraube M10x1x35 - 10.9 boulon / bolt	
30-1035		30-830		30-1035	

Berti IND-06R re/dr/ri IND-06L li/ga/le		Bertolini BER-04R re/dr/ri BER-04L li/ga/le		Bertolini BER-09R re/dr/ri BER-09L li/ga/le		Bertolini BER-11R re/dr/ri BER-11L li/ga/le	
Orig.-Nr. / réf. origine / orig.-part-no.		Orig.-Nr. / réf. origine / orig.-part-no.		Orig.-Nr. / réf. origine / orig.-part-no.		Orig.-Nr. / réf. origine / orig.-part-no.	
				16812 re/dr/ri 16813 li/ga/le			
Gewicht / poids / weight		Gewicht / poids / weight		Gewicht / poids / weight		Gewicht / poids / weight	
0,550		0,490		0,350		0,350	
Schraube M10x1x35 - 10.9 boulon / bolt		Schraube M10x1x35 - 10.9 boulon / bolt		Schraube M10x1x30 - 10.9 boulon / bolt		Schraube M8x1x30 - 10.9 boulon / bolt	
30-1035		30-1035		30-1030		30-830	



Original Muzzi-Fräsmesser mit Garantie / couteaux Muzzi avec garantie / Original warranted Muzzi Blades

- Keine Original-Ersatzteile - Il ne s'agit pas de pièces originales - No genuine spare parts -

Bertolini	
BER-15R re/dr/ri	
BER-15L li/ga/le	
Orig.-Nr. / réf. origine / orig.-part-no.	
12522 re/dr/ri	
12523 li/ga/le	
Gewicht / poids / weight	0,570
Schraube M12x1,25x35 - 12.9 boulon / bolt	30-1235

Bertolini	
BER-16R re/dr/ri	
BER-16L li/ga/le	
Orig.-Nr. / réf. origine / orig.-part-no.	
13014 re/dr/ri	
13015 li/ga/le	
Gewicht / poids / weight	0,410
Schraube M10x1x30 - 10.9 boulon / bolt	30-1030

Bertolini	
BER-18R re/dr/ri	
BER-18L li/ga/le	
Orig.-Nr. / réf. origine / orig.-part-no.	
012031 re/dr/ri	
012032 li/ga/le	
Gewicht / poids / weight	0,750
Schraube M12x1,25x35 - 12.9 boulon / bolt	30-1235

Bertolini	
BER-20R re/dr/ri	
BER-20L li/ga/le	
Orig.-Nr. / réf. origine / orig.-part-no.	
17002 re/dr/ri	
17003 li/ga/le	
Gewicht / poids / weight	0,260
Schraube M8x1x30 - 10.9 boulon / bolt	30-830

Bertolini	
BER-21R re/dr/ri	
BER-21L li/ga/le	
Orig.-Nr. / réf. origine / orig.-part-no.	
15517 re/dr/ri	
15518 li/ga/le	
Gewicht / poids / weight	0,320
Schraube M8x1x30 - 10.9 boulon / bolt	30-830

Bertolini	
BER-22R re/dr/ri	
BER-22L li/ga/le	
Orig.-Nr. / réf. origine / orig.-part-no.	
15517 re/dr/ri	
15518 li/ga/le	
Gewicht / poids / weight	0,270
Schraube M8x1x30 - 10.9 boulon / bolt	30-830

Bertolini	
BER-25R re/dr/ri	
BER-25L li/ga/le	
Orig.-Nr. / réf. origine / orig.-part-no.	
15602 re/dr/ri	
15603 li/ga/le	
Gewicht / poids / weight	0,330
Schraube M8x1x30 - 10.9 boulon / bolt	30-830

Bertolini	
EUR-01R re/dr/ri	
EUR-01L li/ga/le	
Orig.-Nr. / réf. origine / orig.-part-no.	
S.315HP14	
Gewicht / poids / weight	0,160
Schraube M8x1x30 - 10.9 boulon / bolt	30-830

Bertolini	
FER-13R re/dr/ri	
FER-13L li/ga/le	
Orig.-Nr. / réf. origine / orig.-part-no.	
S.315HP14	
Gewicht / poids / weight	0,430
Schraube M10x1x35 - 10.9 boulon / bolt	30-1035

Bertolini	
GRI-01R re/dr/ri	
GRI-01L li/ga/le	
Orig.-Nr. / réf. origine / orig.-part-no.	
S.305HP7,5	
Gewicht / poids / weight	0,290
Schraube M10x1x35 - 10.9 boulon / bolt	30-1035

Bertolini	
NIB-15R re/dr/ri	
NIB-15L li/ga/le	
Orig.-Nr. / réf. origine / orig.-part-no.	
S.305HP7,5	
Gewicht / poids / weight	0,180
Schraube M8x1x30 - 10.9 boulon / bolt	30-830

- Keine Original-Ersatzteile - Il ne s'agit pas de pièces originales - No genuine spare parts -

Maße und Gewichte annähernd und unverbindlich - Les mesures et poids sont approximatifs et sous réserve - Dimensions and weights are approximate and not binding
 Technische Änderungen vorbehalten - Modifications techniques réservées - Technical changes reserved



Original Muzzi-Fräsmesser mit Garantie / couteaux Muzzi avec garantie / Original warranted Muzzi Blades

Fräsmesser u. Rotorzinken nach Fabrikat:
 Couteaux et lames de rotalabour pour machines:
 Blades and knives for spike rotor to fit:

Technische Änderungen vorbehalten - Modifications techniques réservées - Technical changes reserved
 Maße und Gewichte annähernd und unverbindlich - Les mesures et poids sont approximatifs et sous réserve - Dimensions and weights are approximate and not binding

Bertolini	
OMM-01R re/dr/ri	
OMM-01L li/ga/le	
Orig.-Nr. / réf. origine / orig.-part-no.	
BM12-412	
Gewicht / poids / weight	0,500
Schraube M12x1,25x35 - 12.9 boulon / bolt	30-1235

Bonfiglioli	
BON-01R re/dr/ri	
BON-01L li/ga/le	
Orig.-Nr. / réf. origine / orig.-part-no.	
Gewicht / poids / weight	0,550
Schraube M10x1x35 - 10.9 boulon / bolt	30-1035

Braun	
BRA-51R re/dr/ri	
BRA-51L li/ga/le	
Orig.-Nr. / réf. origine / orig.-part-no.	
Gewicht / poids / weight	0,900

Breviglieri	
BRE-02R re/dr/ri	
BRE-02L li/ga/le	
Orig.-Nr. / réf. origine / orig.-part-no.	
M6-M4	
Gewicht / poids / weight	0,460

Breviglieri	
BRE-03R re/dr/ri	
BRE-03L li/ga/le	
Orig.-Nr. / réf. origine / orig.-part-no.	
8300021 re/dr/ri	
8300020 li/ga/le	
Gewicht / poids / weight	0,680
Schraube M12x1,25x35 - 12.9 boulon / bolt	30-1235

Breviglieri	
BRE-04R re/dr/ri	
BRE-04L li/ga/le	
Orig.-Nr. / réf. origine / orig.-part-no.	
8300023 re/dr/ri	
8300022 li/ga/le	
Gewicht / poids / weight	0,720
Schraube M12x1,25x40 - 12.9 boulon / bolt	30-1240

Breviglieri	
BRE-05R re/dr/ri	
BRE-05L li/ga/le	
Orig.-Nr. / réf. origine / orig.-part-no.	
0066046D re/dr/ri	
0066046S li/ga/le	
Gewicht / poids / weight	1,200
Schraube M14x1,5x35 - 12.9 boulon / bolt	30-1435

Breviglieri	
BRE-09R re/dr/ri	
BRE-09L li/ga/le	
Orig.-Nr. / réf. origine / orig.-part-no.	
B2-B12-BV2(20439)	
Gewicht / poids / weight	1,020
Schraube M12x1,25x35 - 12.9 boulon / bolt	30-1235

Breviglieri	
BRE-10R re/dr/ri	
BRE-10L li/ga/le	
Orig.-Nr. / réf. origine / orig.-part-no.	
50150-B4V	
Gewicht / poids / weight	1,350
Schraube M14x1,5x35 - 12.9 boulon / bolt	30-1435

Breviglieri	
BRE-12R re/dr/ri	
BRE-12L li/ga/le	
Orig.-Nr. / réf. origine / orig.-part-no.	
15219D re/dr/ri	
15219S li/ga/le	
Gewicht / poids / weight	0,280
Schraube M8x1x30 - 10.9 boulon / bolt	30-830

Breviglieri	
BRE-13R re/dr/ri	
BRE-13L li/ga/le	
Orig.-Nr. / réf. origine / orig.-part-no.	
8300044 re/dr/ri	
8300043 li/ga/le	
Gewicht / poids / weight	0,340
Schraube M10x1x35 - 10.9 boulon / bolt	30-1035

Original Muzzi-Fräsmesser mit Garantie / couteaux Muzzi avec garantie / Original warranted Muzzi Blades

- Keine Original-Ersatzteile - Il ne s'agit pas de pièces originales - No genuine spare parts -

Breviglieri BRE-14R re/dr/ri BRE-14L li/ga/le	Breviglieri BRE-15R re/dr/ri BRE-15L li/ga/le	Breviglieri BRE-16R re/dr/ri BRE-16L li/ga/le	Breviglieri BRE-19
Orig.-Nr. / réf. origine / orig.-part-no. 0030104D re/dr/ri 0030104S li/ga/le	Orig.-Nr. / réf. origine / orig.-part-no. 1847D re/dr/ri 1847S li/ga/le	Orig.-Nr. / réf. origine / orig.-part-no. 50175D re/dr/ri 50175S li/ga/le	Orig.-Nr. / réf. origine / orig.-part-no.
Gewicht / poids / weight 0,570	Gewicht / poids / weight 0,320	Gewicht / poids / weight 0,900	Gewicht / poids / weight 0,750
Schraube M12x1,25x35 - 12.9 30-1235 boulon / bolt	Schraube M10x1x30 - 10.9 30-1030 boulon / bolt		

Breviglieri BRE-22R re/dr/ri BRE-22L li/ga/le
Orig.-Nr. / réf. origine / orig.-part-no. 0003061D re/dr/ri 0003061S li/ga/le
Gewicht / poids / weight 1,130
Schraube M14x1,5x40 - 12.9 30-1440 boulon / bolt

Breviglieri CEL-07R re/dr/ri CEL-07L li/ga/le
Orig.-Nr. / réf. origine / orig.-part-no. 20322D re/dr/ri 20322S li/ga/le
Gewicht / poids / weight 0,980
Schraube M14x1,5x40 - 12.9 30-1440 boulon / bolt

Breviglieri CEL-09R re/dr/ri CEL-09L li/ga/le
Orig.-Nr. / réf. origine / orig.-part-no. 0064811D re/dr/ri 0064811S li/ga/le
Gewicht / poids / weight 1,200
Schraube M14x1,5x40 - 12.9 30-1440 boulon / bolt

Breviglieri CEL-10R re/dr/ri CEL-10L li/ga/le
Orig.-Nr. / réf. origine / orig.-part-no. 0064818D re/dr/ri 0064818S li/ga/le
Gewicht / poids / weight 1,230
Schraube M14x1,5x40 - 12.9 30-1440 boulon / bolt

Breviglieri HOW-03R re/dr/ri HOW-03L li/ga/le
Orig.-Nr. / réf. origine / orig.-part-no. 20302D re/dr/ri 20302S li/ga/le
Gewicht / poids / weight 0,950
Schraube 1/2"UNF x38 - 12.9 30-3903 boulon / bolt

Breviglieri MAL-01R re/dr/ri MAL-01L li/ga/le
Orig.-Nr. / réf. origine / orig.-part-no. 30329D re/dr/ri 30329S li/ga/le
Gewicht / poids / weight 1,130
Schraube M14x1,5x40 - 12.9 30-1440 boulon / bolt

Breviglieri MAL-03R re/dr/ri MAL-03L li/ga/le
Orig.-Nr. / réf. origine / orig.-part-no. 30412D re/dr/ri 30412S li/ga/le
Gewicht / poids / weight 1,290
Schraube M14x1,5x40 - 12.9 30-1440 boulon / bolt

- Keine Original-Ersatzteile - Il ne s'agit pas de pièces originales - No genuine spare parts -

Maße und Gewichte annähernd und unverbindlich - Les mesures et poids sont approximatifs et sous réserve - Dimensions and weights are approximate and not binding - Technische Änderungen vorbehalten - Modifications techniques réservées - Technical changes reserved



Original Muzzi-Fräsmesser mit Garantie / couteaux Muzzi avec garantie / Original warranted Muzzi Blades

Fräsmesser u. Rotorzinken nach Fabrikat:
 Couteaux et lames de rotalabour pour machines:
 Blades and knives for spike rotor to fit:

Breviglieri

MAS-25R re/dr/ri	
MAS-25L li/ga/le	
Orig.-Nr. / réf. origine / orig.-part-no.	
0071091D re/dr/ri	
0071091S li/ga/le	
Gewicht / poids / weight	1,290
Schraube M10x65 - 8.8 boulon / bolt	
51-1065	

Breviglieri

RH55	
Orig.-Nr. / réf. origine / orig.-part-no.	
01680	
Gewicht / poids / weight	0,650
Schraube M10x65 - 8.8 boulon / bolt	
51-1065	

Brumital-Agris

BRU-04R re/dr/ri	
BRU-04L li/ga/le	
Orig.-Nr. / réf. origine / orig.-part-no.	
Gewicht / poids / weight	0,350
Schraube M10x1x35 - 10.9 boulon / bolt	30-1035

Brumital-Agris

BRU-05R re/dr/ri	
BRU-05L li/ga/le	
Orig.-Nr. / réf. origine / orig.-part-no.	
Gewicht / poids / weight	0,340
Schraube M8x1x30 - 10.9 boulon / bolt	30-830

Brumital-Agris

BRU-06R re/dr/ri	
BRU-06L li/ga/le	
Orig.-Nr. / réf. origine / orig.-part-no.	
Gewicht / poids / weight	0,340
Schraube M10x1x35 - 10.9 boulon / bolt	30-1035

Brumital-Agris

BRU-07R re/dr/ri	
BRU-07L li/ga/le	
Orig.-Nr. / réf. origine / orig.-part-no.	
Gewicht / poids / weight	0,360
Schraube M8x1x30 - 10.9 boulon / bolt	30-830

Brumital-Agris

BRU-09R re/dr/ri	
BRU-09L li/ga/le	
Orig.-Nr. / réf. origine / orig.-part-no.	
Gewicht / poids / weight	0,400
Schraube M8x1x30 - 10.9 boulon / bolt	30-830

Brumital-Agris

BRU-10R re/dr/ri	
BRU-10L li/ga/le	
Orig.-Nr. / réf. origine / orig.-part-no.	
Gewicht / poids / weight	0,400
Schraube M10x1x35 - 10.9 boulon / bolt	30-1035

Brumital-Agris

BRU-11R re/dr/ri	
BRU-11L li/ga/le	
Orig.-Nr. / réf. origine / orig.-part-no.	
Gewicht / poids / weight	0,450
Schraube M8x1x30 - 10.9 boulon / bolt	30-830

Brumital-Agris

BRU-12R re/dr/ri	
BRU-12L li/ga/le	
Orig.-Nr. / réf. origine / orig.-part-no.	
Gewicht / poids / weight	0,450
Schraube M10x1x35 - 10.9 boulon / bolt	30-1035



Original Muzzi-Fräsmesser mit Garantie / couteaux Muzzi avec garantie / Original warranted Muzzi Blades

Technische Änderungen vorbehalten - Modifications techniques réservées - Technical changes reserved
 Maße und Gewichte annähernd und unverbindlich - Les mesures et poids sont approximatifs et sous réserve - Dimensions and weights are approximate and not binding

- Keine Original-Ersatzteile - Il ne s'agit pas de pièces originales - No genuine spare parts -

Brumital-Agris

BRU-13R re/dr/ri	
BRU-13L li/ga/le	
Orig.-Nr. / réf. origine / orig.-part-no.	
Gewicht / poids / weight 0,390	
Schraube M8x1x30 - 10.9 boulon / bolt	30-830

Brumital-Agris

BRU-14R re/dr/ri	
BRU-14L li/ga/le	
Orig.-Nr. / réf. origine / orig.-part-no.	
Gewicht / poids / weight 0,390	
Schraube M10x1x35 - 10.9 boulon / bolt	30-1035

Brumital-Agris

BRU-16R re/dr/ri	
BRU-16L li/ga/le	
Orig.-Nr. / réf. origine / orig.-part-no.	
Gewicht / poids / weight 0,410	
Schraube M10x1x35 - 10.9 boulon / bolt	30-1035

Brumital-Agris

BRU-18R re/dr/ri	
BRU-18L li/ga/le	
Orig.-Nr. / réf. origine / orig.-part-no.	
Gewicht / poids / weight 0,430	
Schraube M10x1x35 - 10.9 boulon / bolt	30-1035

Brumital-Agris

BRU-19R re/dr/ri	
BRU-19L li/ga/le	
Orig.-Nr. / réf. origine / orig.-part-no.	
Gewicht / poids / weight 0,580	
Schraube M10x1x35 - 10.9 boulon / bolt	30-1035

Brumital-Agris

BRU-21R re/dr/ri	
BRU-21L li/ga/le	
Orig.-Nr. / réf. origine / orig.-part-no.	
Gewicht / poids / weight 0,140	
Schraube M8x1x30 - 10.9 boulon / bolt	30-830

Brumital-Agris

BRU-22R re/dr/ri	
BRU-22L li/ga/le	
Orig.-Nr. / réf. origine / orig.-part-no.	
Gewicht / poids / weight 0,270	
Schraube M8x1x30 - 10.9 boulon / bolt	30-830

Brumital-Agris

BRU-25R re/dr/ri	
BRU-25L li/ga/le	
Orig.-Nr. / réf. origine / orig.-part-no.	
Gewicht / poids / weight 0,330	
Schraube M8x1x30 - 10.9 boulon / bolt	30-830

Brumital-Agris

BRU-26R re/dr/ri	
BRU-26L li/ga/le	
Orig.-Nr. / réf. origine / orig.-part-no.	
Gewicht / poids / weight 0,310	
Schraube M8x1x30 - 10.9 boulon / bolt	30-830

Brumital-Agris

BRU-27R re/dr/ri	
BRU-27L li/ga/le	
Orig.-Nr. / réf. origine / orig.-part-no.	
Gewicht / poids / weight 0,350	
Schraube M8x1x30 - 10.9 boulon / bolt	30-830

Brumital-Agris

BRU-30R re/dr/ri	
BRU-30L li/ga/le	
Orig.-Nr. / réf. origine / orig.-part-no.	
Gewicht / poids / weight 0,500	
Schraube M10x1x35 - 10.9 boulon / bolt	30-1035

- Keine Original-Ersatzteile - Il ne s'agit pas de pièces originales - No genuine spare parts -

Maße und Gewichte annähernd und unverbindlich - Les mesures et poids sont approximatifs et sous réserve - Dimensions and weights are approximate and not binding
 Technische Änderungen vorbehalten - Modifications techniques réservées - Technical changes reserved



Original Muzzi-Fräsmesser mit Garantie / couteaux Muzzi avec garantie / Original warranted Muzzi Blades

Fräsmesser u. Rotorzinken nach Fabrikat:
 Couteaux et lames de rotalabour pour machines:
 Blades and knives for spike rotor to fit:

Technische Änderungen vorbehalten - Modifications techniques réservées - Technical changes reserved
 Maße und Gewichte annähernd und unverbindlich - Les mesures et poids sont approximatifs et sous réserve - Dimensions and weights are approximate and not binding

Brumital-Agris	
BRU-31R re/dr/ri	
BRU-31L li/ga/le	
Orig.-Nr. / réf. origine / orig.-part-no.	
Gewicht / poids / weight 0,450	
Schraube M10x1x35 - 10.9 boulon / bolt	30-1035

Brumital-Agris	
BRU-32R re/dr/ri	
BRU-32L li/ga/le	
Orig.-Nr. / réf. origine / orig.-part-no.	
Gewicht / poids / weight 0,520	
Schraube M10x1x35 - 10.9 boulon / bolt	30-1035

Brumital-Agris	
BRU-45R re/dr/ri	
BRU-45L li/ga/le	
Orig.-Nr. / réf. origine / orig.-part-no.	
Gewicht / poids / weight 0,400	
Schraube M8x1x30 - 10.9 boulon / bolt	30-830

Bungartz	
BUN-51R re/dr/ri	
BUN-51L li/ga/le	
Orig.-Nr. / réf. origine / orig.-part-no.	
A5308 re/dr/ri	
A5307 li/ga/le	
Gewicht / poids / weight 0,680	

Bungartz	
BUN-52R re/dr/ri	
BUN-52L li/ga/le	
Orig.-Nr. / réf. origine / orig.-part-no.	
N5265 re/dr/ri	
N5266 li/ga/le	
Gewicht / poids / weight 0,450	

Bungartz	
BUN-54R re/dr/ri	
BUN-54L li/ga/le	
Orig.-Nr. / réf. origine / orig.-part-no.	
E52056 re/dr/ri	
E52057 li/ga/le	
Gewicht / poids / weight 0,200	

CAB	
CAB-06R re/dr/ri	
CAB-06L li/ga/le	
Orig.-Nr. / réf. origine / orig.-part-no.	
RINGO M10	
Gewicht / poids / weight 0,390	
Schraube M10x1x30 - 10.9 boulon / bolt	30-1030

Calderoni	
BON-01R re/dr/ri	
BON-01L li/ga/le	
Orig.-Nr. / réf. origine / orig.-part-no.	
Gewicht / poids / weight 0,550	

Carraro Antonio	
CAR-02R re/dr/ri	
CAR-02L li/ga/le	
Orig.-Nr. / réf. origine / orig.-part-no.	
6809002 re/dr/ri	
6809006 li/ga/le	
Gewicht / poids / weight 0,480	

Carraro Antonio	
CAR-03R re/dr/ri	
CAR-03L li/ga/le	
Orig.-Nr. / réf. origine / orig.-part-no.	
6809007 re/dr/ri	
6809008 li/ga/le	
Gewicht / poids / weight 0,270	
Schraube M8x1x30 - 10.9 boulon / bolt	30-830

Original Muzzi-Fräsmesser mit Garantie / couteaux Muzzi avec garantie / Original warranted Muzzi Blades

- Keine Original-Ersatzteile - Il ne s'agit pas de pièces originales - No genuine spare parts -

Carraro Antonio

CAR-04R re/dr/ri	
CAR-04L li/ga/le	
Orig.-Nr. / réf. origine / orig.-part-no.	
Gewicht / poids / weight 0,890	
Schraube M14x1,5x40 - 12.9 boulon / bolt	30-1440

Carraro Antonio

CAR-11R re/dr/ri	
CAR-11L li/ga/le	
Orig.-Nr. / réf. origine / orig.-part-no.	
37935004 re/dr/ri 37935005 li/ga/le	
Gewicht / poids / weight 0,280	
Schraube M8x1x30 - 10.9 boulon / bolt	30-830

Carraro S.p.A.

CRR-01R re/dr/ri	
CRR-01L li/ga/le	
Orig.-Nr. / réf. origine / orig.-part-no.	
Gewicht / poids / weight 1,000	
Schraube M12x1,25x35 - 12.9 boulon / bolt	30-1235

Carraro S.p.A.

CRR-02R re/dr/ri	
CRR-02L li/ga/le	
Orig.-Nr. / réf. origine / orig.-part-no.	
Gewicht / poids / weight 1,000	
Schraube M12x1,25x35 - 12.9 boulon / bolt	30-1235

Carraro S.p.A.

CRR-03R re/dr/ri	
CRR-03L li/ga/le	
Orig.-Nr. / réf. origine / orig.-part-no.	
Gewicht / poids / weight 0,600	
Schraube M12x1,25x35 - 12.9 boulon / bolt	30-1235

Carraro S.p.A.

CRR-04R re/dr/ri	
CRR-04L li/ga/le	
Orig.-Nr. / réf. origine / orig.-part-no.	
Gewicht / poids / weight 1,430	
Schraube M12x1,25x40 - 12.9 boulon / bolt	30-1240

Carraro S.p.A.

CRR-05R re/dr/ri	
CRR-05L li/ga/le	
Orig.-Nr. / réf. origine / orig.-part-no.	
Gewicht / poids / weight 1,430	
Schraube M12x1,25x40 - 12.9 boulon / bolt	30-1240

Casorzo

CAS-03R re/dr/ri	
CAS-03L li/ga/le	
Orig.-Nr. / réf. origine / orig.-part-no.	
SU3-CU6	
Gewicht / poids / weight 0,340	
Schraube M8x1x30 - 10.9 boulon / bolt	30-830

Casorzo

CAS-06R re/dr/ri	
CAS-06L li/ga/le	
Orig.-Nr. / réf. origine / orig.-part-no.	
Gewicht / poids / weight 0,350	
Schraube M8x1x30 - 10.9 boulon / bolt	30-830

Casorzo

CAS-08R re/dr/ri	
CAS-08L li/ga/le	
Orig.-Nr. / réf. origine / orig.-part-no.	
Gewicht / poids / weight 0,340	
Schraube M8x1x30 - 10.9 boulon / bolt	30-830

Casorzo

CAS-09R re/dr/ri	
CAS-09L li/ga/le	
Orig.-Nr. / réf. origine / orig.-part-no.	
Gewicht / poids / weight 0,400	
Schraube M8x1x30 - 10.9 boulon / bolt	30-830

Casorzo

CAS-10R re/dr/ri	
CAS-10L li/ga/le	
Orig.-Nr. / réf. origine / orig.-part-no.	
Gewicht / poids / weight 0,300	
Schraube M8x1x30 - 10.9 boulon / bolt	30-830

- Keine Original-Ersatzteile - Il ne s'agit pas de pièces originales - No genuine spare parts -

Maße und Gewichte annähernd und unverbindlich - Les mesures et poids sont approximatifs et sous réserve - Dimensions and weights are approximate and not binding - Technische Änderungen vorbehalten - Modifications techniques réservées - Technical changes reserved



Original Muzzi-Fräsmesser mit Garantie / couteaux Muzzi avec garantie / Original warranted Muzzi Blades

Fräsmesser u. Rotorzinken nach Fabrikat:
 Couteaux et lames de rotalabour pour machines:
 Blades and knives for spike rotor to fit:

Technische Änderungen vorbehalten - Modifications techniques réservées - Technical changes reserved
 Maße und Gewichte annähernd und unverbindlich - Les mesures et poids sont approximatifs et sous réserve - Dimensions and weights are approximate and not binding

Casorzo	
CAS-11R re/dr/ri	
CAS-11L li/ga/le	
Orig.-Nr. / réf. origine / orig.-part-no.	
CU125	
Gewicht / poids / weight	0,300
Schraube M8x1x30 - 10.9 boulon / bolt	30-830

Casorzo	
CAS-12R re/dr/ri	
CAS-12L li/ga/le	
Orig.-Nr. / réf. origine / orig.-part-no.	
SU4-CU6	
Gewicht / poids / weight	0,400
Schraube M10x1x35 - 10.9 boulon / bolt	30-1035

Celli	
CEL-01R re/dr/ri	
CEL-01L li/ga/le	
Orig.-Nr. / réf. origine / orig.-part-no.	
522505 re/dr/ri	
522506 li/ga/le	
Gewicht / poids / weight	0,720
Schraube M12x1,25x35 - 12.9 boulon / bolt	30-1235

Celli	
CEL-03R re/dr/ri	
CEL-03L li/ga/le	
Orig.-Nr. / réf. origine / orig.-part-no.	
Gewicht / poids / weight	0,990
Schraube M14x1,5x40 - 12.9 boulon / bolt	30-1440

Celli	
CEL-04R re/dr/ri	
CEL-04L li/ga/le	
Orig.-Nr. / réf. origine / orig.-part-no.	
Gewicht / poids / weight	1,280
Schraube M14x1,5x40 - 12.9 boulon / bolt	30-1440

Celli	
CEL-05R re/dr/ri	
CEL-05L li/ga/le	
Orig.-Nr. / réf. origine / orig.-part-no.	
322518 re/dr/ri	
322519 li/ga/le	
Gewicht / poids / weight	0,820
Schraube M14x1,5x40 - 12.9 boulon / bolt	30-1440

Celli	
CEL-06R re/dr/ri	
CEL-06L li/ga/le	
Orig.-Nr. / réf. origine / orig.-part-no.	
322516 re/dr/ri	
322517 li/ga/le	
Gewicht / poids / weight	0,840
Schraube M14x1,5x40 - 12.9 boulon / bolt	30-1440

Celli	
CEL-07R re/dr/ri	
CEL-07L li/ga/le	
Orig.-Nr. / réf. origine / orig.-part-no.	
422514 re/dr/ri	
422515 li/ga/le	
Gewicht / poids / weight	0,980
Schraube M14x1,5x40 - 12.9 boulon / bolt	30-1440

Celli	
CEL-08R re/dr/ri	
CEL-08L li/ga/le	
Orig.-Nr. / réf. origine / orig.-part-no.	
422512 re/dr/ri	
422513 li/ga/le	
Gewicht / poids / weight	1,000
Schraube M14x1,5x40 - 12.9 boulon / bolt	30-1440

Celli	
CEL-09R re/dr/ri	
CEL-09L li/ga/le	
Orig.-Nr. / réf. origine / orig.-part-no.	
722537 re/dr/ri	
722538 li/ga/le	
Gewicht / poids / weight	1,200
Schraube M14x1,5x40 - 12.9 boulon / bolt	30-1440

Celli	
CEL-10R re/dr/ri	
CEL-10L li/ga/le	
Orig.-Nr. / réf. origine / orig.-part-no.	
722533 re/dr/ri	
722534 li/ga/le	
Gewicht / poids / weight	1,230
Schraube M14x1,5x40 - 12.9 boulon / bolt	30-1440



Original Muzzi-Fräsmesser mit Garantie / couteaux Muzzi avec garantie / Original warranted Muzzi Blades

- Keine Original-Ersatzteile - Il ne s'agit pas de pièces originales - No genuine spare parts -

Fräsmesser u. Rotorzinken nach Fabrikat:
 Couteaux et lames de rotalabour pour machines:
 Blades and knives for spike rotor to fit:

Celli	
CEL-11R re/dr/ri	
CEL-11L li/ga/le	
Orig.-Nr. / réf. origine / orig.-part-no.	
422516 re/dr/ri	
422517 li/ga/le	
Gewicht / poids / weight	1,050
Schraube M14x1,5x40 - 12.9 boulon / bolt	30-1440

Celli	
CEL-12R re/dr/ri	
CEL-12L li/ga/le	
Orig.-Nr. / réf. origine / orig.-part-no.	
Gewicht / poids / weight	
1,130	
Schraube M14x1,5x40 - 12.9 boulon / bolt	30-1440

Celli	
CEL-13R re/dr/ri	
CEL-13L li/ga/le	
Orig.-Nr. / réf. origine / orig.-part-no.	
522600 re/dr/ri	
522601 li/ga/le	
Gewicht / poids / weight	0,580
Schraube M12x1,25x35 - 12.9 boulon / bolt	30-1235

Celli	
CEL-14R re/dr/ri	
CEL-14L li/ga/le	
Orig.-Nr. / réf. origine / orig.-part-no.	
522602 re/dr/ri	
522603 li/ga/le	
Gewicht / poids / weight	0,580
Schraube M12x1,25x35 - 12.9 boulon / bolt	30-1235

Celli	
CEL-15R re/dr/ri	
CEL-15L li/ga/le	
Orig.-Nr. / réf. origine / orig.-part-no.	
422526 re/dr/ri	
422527 li/ga/le	
Gewicht / poids / weight	0,760

Celli	
CEL-16R re/dr/ri	
CEL-16L li/ga/le	
Orig.-Nr. / réf. origine / orig.-part-no.	
422630 re/dr/ri	
422631 li/ga/le	
Gewicht / poids / weight	0,950
Schraube M16x1,5x52 - 12.9 boulon / bolt	30-1652

Celli	
CEL-18R re/dr/ri	
CEL-18L li/ga/le	
Orig.-Nr. / réf. origine / orig.-part-no.	
522514 re/dr/ri	
522515 li/ga/le	
Gewicht / poids / weight	0,800
Schraube M12x1,25x35 - 12.9 boulon / bolt	30-1235

Celli	
CEL-19R re/dr/ri	
CEL-19L li/ga/le	
Orig.-Nr. / réf. origine / orig.-part-no.	
722547 re/dr/ri	
722548 li/ga/le	
Gewicht / poids / weight	1,530

Celli	
CEL-20R re/dr/ri	
CEL-20L li/ga/le	
Orig.-Nr. / réf. origine / orig.-part-no.	
331528 re/dr/ri	
331529 li/ga/le	
Gewicht / poids / weight	0,870
Schraube M14x1,5x40 - 12.9 boulon / bolt	30-1440

Celli	
CEL-21R re/dr/ri	
CEL-21L li/ga/le	
Orig.-Nr. / réf. origine / orig.-part-no.	
331526 re/dr/ri	
331527 li/ga/le	
Gewicht / poids / weight	0,900
Schraube M14x1,5x40 - 12.9 boulon / bolt	30-1440

Celli	
CEL-22R re/dr/ri	
CEL-22L li/ga/le	
Orig.-Nr. / réf. origine / orig.-part-no.	
531511 re/dr/ri	
531512 li/ga/le	
Gewicht / poids / weight	0,580
Schraube M12x1,25x40 - 12.9 boulon / bolt	30-1240

Celli	
CEL-24	
Orig.-Nr. / réf. origine / orig.-part-no.	
Gewicht / poids / weight	1,040

- Keine Original-Ersatzteile - Il ne s'agit pas de pièces originales - No genuine spare parts -

Maße und Gewichte annähernd und unverbindlich - Les mesures et poids sont approximatifs et sous réserve - Dimensions and weights are approximate and not binding - Technische Änderungen vorbehalten - Modifications techniques réservées - Technical changes reserved

Original Muzzi-Fräsmesser mit Garantie / couteaux Muzzi avec garantie / Original warranted Muzzi Blades

Fräsmesser u. Rotorzinken nach Fabrikat:
 Couteaux et lames de rotalabour pour machines:
 Blades and knives for spike rotor to fit:

Technische Änderungen vorbehalten - Modifications techniques réservées - Technical changes reserved
 Maße und Gewichte annähernd und unverbindlich - Les mesures et poids sont approximatifs et sous réserve - Dimensions and weights are approximate and not binding

Celli
CEL-31R re/dr/ri
CEL-31L li/ga/le **NEU**

Orig.-Nr. / réf. origine / orig.-part-no.
 722557 re/dr/ri
 722558 li/ga/le

Gewicht / poids / weight 1,420

Celli
CEL-38R re/dr/ri
CEL-38L li/ga/le **NEU**

Orig.-Nr. / réf. origine / orig.-part-no.
 722560 re/dr/ri
 722561 li/ga/le

Gewicht / poids / weight 1,500

Celli
CEL-39R re/dr/ri
CEL-39L li/ga/le **NEU**

Orig.-Nr. / réf. origine / orig.-part-no.
 722562 re/dr/ri
 722563 li/ga/le

Gewicht / poids / weight 1,450

Celli
FMO-05R re/dr/ri
FMO-05L li/ga/le

Orig.-Nr. / réf. origine / orig.-part-no.

Gewicht / poids / weight 0,500

Schraube
 M10x1x35 - 10.9
 boulon / bolt **30-1035**

Celli
MAS-25R re/dr/ri
MAS-25L li/ga/le

Orig.-Nr. / réf. origine / orig.-part-no.

Gewicht / poids / weight 0,800

Comeb
COM-01R re/dr/ri
COM-01L li/ga/le

Orig.-Nr. / réf. origine / orig.-part-no.

Gewicht / poids / weight 0,240

Schraube
 M10x1x35 - 10.9
 boulon / bolt **30-1035**

Comeb
COM-02R re/dr/ri
COM-02L li/ga/le

Orig.-Nr. / réf. origine / orig.-part-no.

Gewicht / poids / weight 0,280

Schraube
 M10x1x35 - 10.9
 boulon / bolt **30-1035**

Comeb
COM-03R re/dr/ri
COM-03L li/ga/le

Orig.-Nr. / réf. origine / orig.-part-no.

Gewicht / poids / weight 0,210

Schraube
 M10x1x35 - 10.9
 boulon / bolt **30-1035**

Comeb
COM-06R re/dr/ri
COM-06L li/ga/le

Orig.-Nr. / réf. origine / orig.-part-no.

Gewicht / poids / weight 0,220

Schraube
 M10x1x35 - 10.9
 boulon / bolt **30-1035**

Comeb
COM-07R re/dr/ri
COM-07L li/ga/le

Orig.-Nr. / réf. origine / orig.-part-no.

Gewicht / poids / weight 0,440

Schraube
 M12x1,25x35 - 12.9
 boulon / bolt **30-1235**

Comeb
COM-10 **NEU**

Orig.-Nr. / réf. origine / orig.-part-no.

Gewicht / poids / weight 1,000

Comeb
COM-11R re/dr/ri
COM-11L li/ga/le **NEU**

Orig.-Nr. / réf. origine / orig.-part-no.

Gewicht / poids / weight 0,310

Schraube
 M10x1x35 - 10.9
 boulon / bolt **30-1035**

Original Muzzi-Fräsmesser mit Garantie / couteaux Muzzi avec garantie / Original warranted Muzzi Blades

- Keine Original-Ersatzteile - Il ne s'agit pas de pièces originales - No genuine spare parts -

Fräsmesser u. Rotorzinken nach Fabrikat:
 Couteaux et lames de rotalabour pour machines:
 Blades and knives for spike rotor to fit:

Comeb

COM-12R re/dr/ri	
COM-12L li/ga/le NEU	
Orig.-Nr. / réf. origine / orig.-part-no.	
Gewicht / poids / weight 1,240	
Schraube M8x1x30 - 10.9 30-830	

Comeb

COM-13R re/dr/ri	
COM-13L li/ga/le NEU	
Orig.-Nr. / réf. origine / orig.-part-no.	
Gewicht / poids / weight 1,200	
Schraube M8x1x30 - 10.9 30-830	

Del Morino

DLM-01R re/dr/ri	
DLM-01L li/ga/le	
Orig.-Nr. / réf. origine / orig.-part-no.	
Gewicht / poids / weight 0,560	
Schraube M8x1x30 - 10.9 30-830	

Diesse

DIE-01R re/dr/ri	
DIE-01L li/ga/le	
Orig.-Nr. / réf. origine / orig.-part-no.	
Gewicht / poids / weight 0,330	
Schraube M8x1x30 - 10.9 30-830	

Diesse

DIE-02R re/dr/ri	
DIE-02L li/ga/le	
Orig.-Nr. / réf. origine / orig.-part-no.	
Gewicht / poids / weight 0,420	
Schraube M10x1x35 - 10.9 30-1035	

Diesse

DIE-03R re/dr/ri	
DIE-03L li/ga/le	
Orig.-Nr. / réf. origine / orig.-part-no.	
Gewicht / poids / weight 0,490	
Schraube M10x1x35 - 10.9 30-1035	

Dondi

DON-06R re/dr/ri	
DON-06L li/ga/le	
Orig.-Nr. / réf. origine / orig.-part-no.	
Gewicht / poids / weight 0,730	
Schraube M12x1,25x35 - 12.9 30-1235	

Dondi

DON-07R re/dr/ri	
DON-07L li/ga/le	
Orig.-Nr. / réf. origine / orig.-part-no.	
Gewicht / poids / weight 0,850	
Schraube M12x1,25x35 - 12.9 30-1235	

Dondi

DON-10R re/dr/ri	
DON-10L li/ga/le	
Orig.-Nr. / réf. origine / orig.-part-no.	
Gewicht / poids / weight 0,470	
Schraube M12x1,25x35 - 12.9 30-1235	

Dondi

DON-12R re/dr/ri	
DON-12L li/ga/le	
Orig.-Nr. / réf. origine / orig.-part-no.	
Gewicht / poids / weight 1,040	
Schraube M14x1,5x40 - 12.9 30-1440	

Dondi

FES-01R re/dr/ri	
FES-01L li/ga/le	
Orig.-Nr. / réf. origine / orig.-part-no.	
Gewicht / poids / weight 1,220	
Schraube M14x1,5x40 - 12.9 30-1440	

Dondi

GOL-33R re/dr/ri	
GOL-33L li/ga/le	
Orig.-Nr. / réf. origine / orig.-part-no.	
Gewicht / poids / weight 0,720	
Schraube M12x1,25x35 - 12.9 30-1235	

- Keine Original-Ersatzteile - Il ne s'agit pas de pièces originales - No genuine spare parts -

Maße und Gewichte annähernd und unverbindlich - Les mesures et poids sont approximatifs et sous réserve - Dimensions and weights are approximate and not binding - Technische Änderungen vorbehalten - Modifications techniques réservées - Technical changes reserved



Original Muzzi-Fräsmesser mit Garantie / couteaux Muzzi avec garantie / Original warranted Muzzi Blades

Fräsmesser u. Rotorzinken nach Fabrikat:
 Couteaux et lames de rotalabour pour machines:
 Blades and knives for spike rotor to fit:

Technische Änderungen vorbehalten - Modifications techniques réservées - Technical changes reserved
 Maße und Gewichte annähernd und unverbindlich - Les mesures et poids sont approximatifs et sous réserve - Dimensions and weights are approximate and not binding

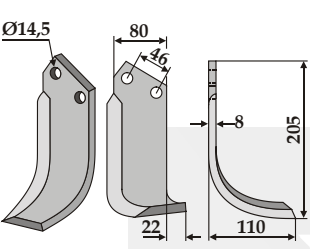
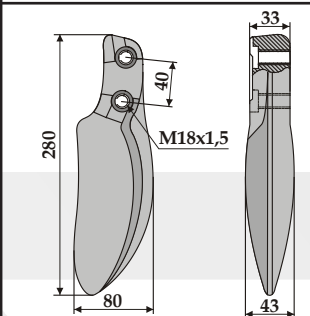
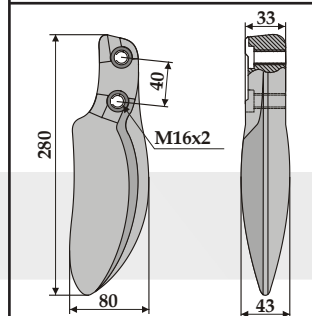
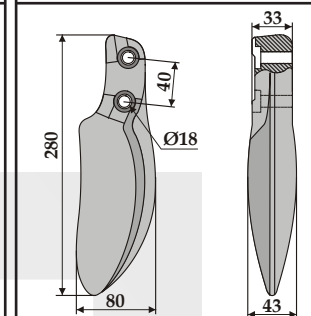
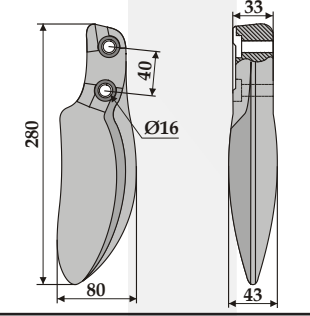
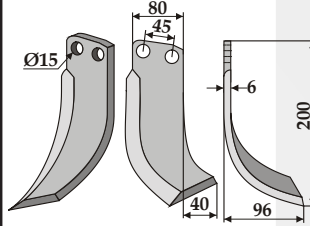
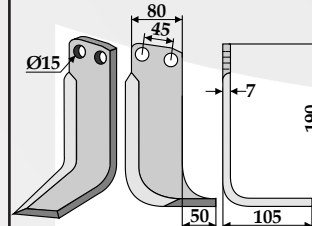
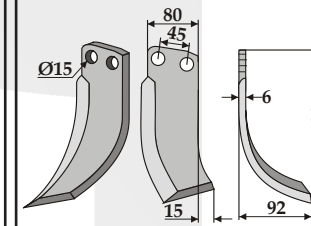
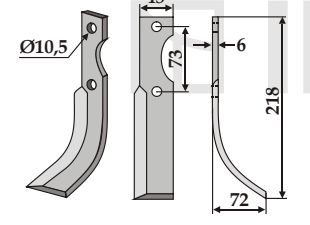
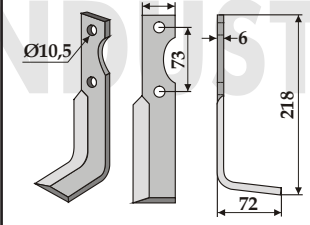
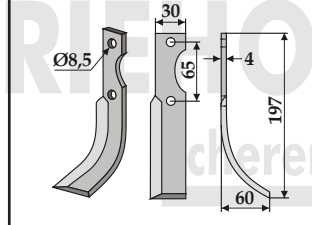
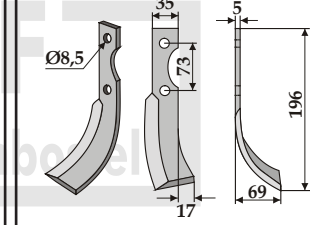
Dondi MAL-01R re/dr/ri MAL-01L li/ga/le  Orig.-Nr. / réf. origine / orig.-part-no. 25.1.046.002 Gewicht / poids / weight 1,170 Schraube M14x1,5x40 - 12.9 30-1440 boulon / bolt		Dutzi RH106/A  Orig.-Nr. / réf. origine / orig.-part-no. 25.1.046.002 Gewicht / poids / weight 2,060		Dutzi RH106/B  Orig.-Nr. / réf. origine / orig.-part-no. 10126 Gewicht / poids / weight 2,060 Schraube M16x2x40 - 10.9 51-1034 boulon / bolt		Dutzi RH106/C  Orig.-Nr. / réf. origine / orig.-part-no. 25.2.046.001.1 Gewicht / poids / weight 2,060	
Dutzi RH106/D  Orig.-Nr. / réf. origine / orig.-part-no. 10127 Gewicht / poids / weight 2,060 Schraube M16x2x55 - 12.9 51-1023 boulon / bolt		Eberhardt EBE-01R re/dr/ri EBE-01L li/ga/le  Orig.-Nr. / réf. origine / orig.-part-no. 1560 re/dr/ri 1561 li/ga/le Gewicht / poids / weight 0,800 Schraube M14x1,5x35 - 12.9 30-1435 boulon / bolt		Eberhardt EBE-02R re/dr/ri EBE-02L li/ga/le  Orig.-Nr. / réf. origine / orig.-part-no. 1530 re/dr/ri 1531 li/ga/le Gewicht / poids / weight 1,060 Schraube M14x1,5x35 - 12.9 30-1435 boulon / bolt		Eberhardt EBE-03R re/dr/ri EBE-03L li/ga/le  Orig.-Nr. / réf. origine / orig.-part-no. 1570 re/dr/ri 1571 li/ga/le Gewicht / poids / weight 0,760 Schraube M14x1,5x35 - 12.9 30-1435 boulon / bolt	
Eurogreen EGR-01R re/dr/ri EGR-01L li/ga/le  Orig.-Nr. / réf. origine / orig.-part-no. 30-1035 Gewicht / poids / weight 0,460 Schraube M10x1x35 - 10.9 30-1035 boulon / bolt		Eurogreen EGR-02R re/dr/ri EGR-02L li/ga/le  Orig.-Nr. / réf. origine / orig.-part-no. 30-1035 Gewicht / poids / weight 0,470 Schraube M10x1x35 - 10.9 30-1035 boulon / bolt		Eurosystems EUR-01R re/dr/ri EUR-01L li/ga/le  Orig.-Nr. / réf. origine / orig.-part-no. F1233102 re/dr/ri F1233103 li/ga/le Gewicht / poids / weight 0,160 Schraube M8x1x30 - 10.9 30-830 boulon / bolt		Eurosystems EUR-02R re/dr/ri EUR-02L li/ga/le  Orig.-Nr. / réf. origine / orig.-part-no. 30-830 Gewicht / poids / weight 0,270 Schraube M8x1x30 - 10.9 30-830 boulon / bolt	



Original Muzzi-Fräsmesser mit Garantie / couteaux Muzzi avec garantie / Original warranted Muzzi Blades

- Keine Original-Ersatzteile - Il ne s'agit pas de pièces originales - No genuine spare parts -

Eurosystems

EUR-03R re/dr/ri	
EUR-03L li/ga/le	
Orig.-Nr. / réf. origine / orig.-part-no.	
Gewicht / poids / weight 0,400	
Schraube M10x1x35 - 10.9 boulon / bolt	30-1035

Eurosystems

EUR-06R re/dr/ri	
EUR-06L li/ga/le	
Orig.-Nr. / réf. origine / orig.-part-no.	
Gewicht / poids / weight 0,230	
Schraube M8x1x30 - 10.9 boulon / bolt	30-830

Eurosystems

FER-25R re/dr/ri	
FER-25L li/ga/le	
Orig.-Nr. / réf. origine / orig.-part-no.	
Gewicht / poids / weight 0,230	
Schraube M10x1x35 - 10.9 boulon / bolt	30-1035

Eurosystems

PAB-02R re/dr/ri	
PAB-02L li/ga/le	
Orig.-Nr. / réf. origine / orig.-part-no.	
Gewicht / poids / weight 0,440	
Schraube M10x1x35 - 10.9 boulon / bolt	30-1035

Fahr

FAH-01R re/dr/ri	
FAH-01L li/ga/le	
Orig.-Nr. / réf. origine / orig.-part-no.	
SE1C62A	
Gewicht / poids / weight 0,940	

Falc

CEL-07R re/dr/ri	
CEL-07L li/ga/le	
Orig.-Nr. / réf. origine / orig.-part-no.	
Gewicht / poids / weight 0,980	
Schraube M14x1,5x40 - 12.9 boulon / bolt	30-1440

Falc

FAL-07R re/dr/ri	
FAL-07L li/ga/le	
Orig.-Nr. / réf. origine / orig.-part-no.	
Gewicht / poids / weight 1,000	

Falc

RH55	
Orig.-Nr. / réf. origine / orig.-part-no.	
240131	
Gewicht / poids / weight 0,650	
Schraube M10x65 - 8.8 boulon / bolt	51-1065

Falc

RH551 re/dr/ri	
RH552 li/ga/le	
Orig.-Nr. / réf. origine / orig.-part-no.	
Gewicht / poids / weight 0,710	

Falconero

CEL-07R re/dr/ri	
CEL-07L li/ga/le	
Orig.-Nr. / réf. origine / orig.-part-no.	
Gewicht / poids / weight 0,980	
Schraube M14x1,5x40 - 12.9 boulon / bolt	30-1440

Falconero

FLN-01R re/dr/ri	
FLN-01L li/ga/le	
Orig.-Nr. / réf. origine / orig.-part-no.	
Gewicht / poids / weight 0,980	

- Keine Original-Ersatzteile - Il ne s'agit pas de pièces originales - No genuine spare parts -

Maße und Gewichte annähernd und unverbindlich - Les mesures et poids sont approximatifs et sous réserve - Dimensions and weights are approximate and not binding - Technische Änderungen vorbehalten - Modifications techniques réservées - Technical changes reserved



Original Muzzi-Fräsmesser mit Garantie / couteaux Muzzi avec garantie / Original warranted Muzzi Blades

Fräsmesser u. Rotorzinken nach Fabrikat:
 Couteaux et lames de rotalabour pour machines:
 Blades and knives for spike rotor to fit:

Technische Änderungen vorbehalten - Modifications techniques réservées - Technical changes reserved
 Maße und Gewichte annähernd und unverbindlich - Les mesures et poids sont approximatifs et sous réserve - Dimensions and weights are approximate and not binding

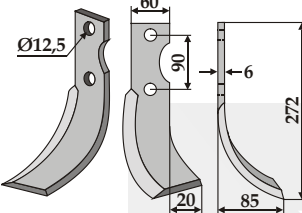
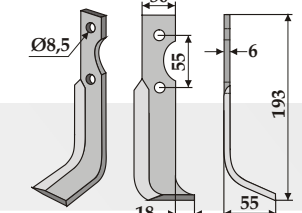
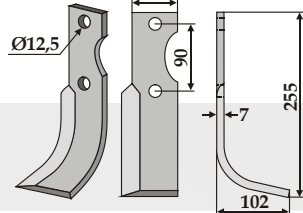
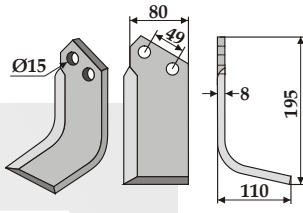
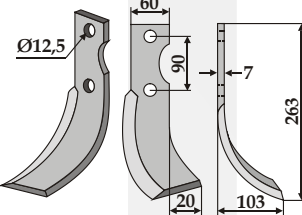
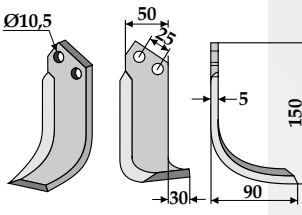
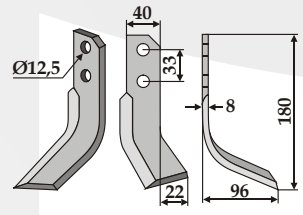
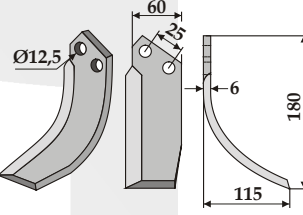
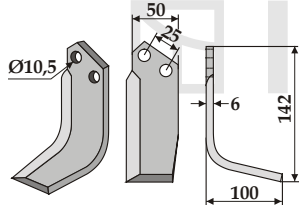
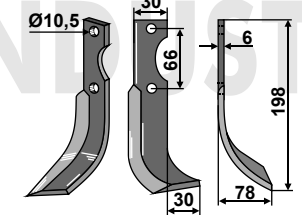
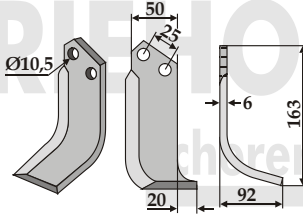
Ferrari ADR-01R re/dr/ri ADR-01L li/ga/le  Orig.-Nr. / réf. origine / orig.-part-no. _____ _____ Gewicht / poids / weight 0,780 Schraube M12x1,25x35 - 12.9 30-1235 boulon / bolt	Ferrari BCS-13R re/dr/ri BCS-13L li/ga/le  Orig.-Nr. / réf. origine / orig.-part-no. _____ _____ Gewicht / poids / weight 0,270 Schraube M8x1x30 - 10.9 30-830 boulon / bolt	Ferrari BER-18R re/dr/ri BER-18L li/ga/le  Orig.-Nr. / réf. origine / orig.-part-no. _____ _____ Gewicht / poids / weight 0,750 Schraube M12x1,25x35 - 12.9 30-1235 boulon / bolt	Ferrari FER-01R re/dr/ri FER-01L li/ga/le  Orig.-Nr. / réf. origine / orig.-part-no. _____ _____ Gewicht / poids / weight 1,060 Schraube M14x1,5x40 - 12.9 30-1440 boulon / bolt
Ferrari FER-02R re/dr/ri FER-02L li/ga/le  Orig.-Nr. / réf. origine / orig.-part-no. _____ _____ Gewicht / poids / weight 0,900 Schraube M12x1,25x35 - 12.9 30-1235 boulon / bolt	Ferrari FER-04R re/dr/ri FER-04L li/ga/le  Orig.-Nr. / réf. origine / orig.-part-no. _____ _____ Gewicht / poids / weight 0,380	Ferrari FER-05R re/dr/ri FER-05L li/ga/le  Orig.-Nr. / réf. origine / orig.-part-no. _____ _____ Gewicht / poids / weight 0,480	Ferrari FER-07R re/dr/ri FER-07L li/ga/le  Orig.-Nr. / réf. origine / orig.-part-no. _____ MC60/68 Gewicht / poids / weight 0,550
Ferrari FER-10R re/dr/ri FER-10L li/ga/le  Orig.-Nr. / réf. origine / orig.-part-no. 496367 re/dr/ri 496366 li/ga/le Gewicht / poids / weight 0,400 Schraube M10x1x30 - 10.9 30-1030 boulon / bolt	Ferrari FER-12R re/dr/ri FER-12L li/ga/le NEU  Orig.-Nr. / réf. origine / orig.-part-no. _____ _____ Gewicht / poids / weight 0,400 Schraube M10x1x35 - 10.9 30-1035 boulon / bolt	Ferrari FER-13R re/dr/ri FER-13L li/ga/le  Orig.-Nr. / réf. origine / orig.-part-no. 72 Super Gewicht / poids / weight 0,430 Schraube M10x1x30 - 10.9 30-1030 boulon / bolt	



Original Muzzi-Fräsmesser mit Garantie / couteaux Muzzi avec garantie / Original warranted Muzzi Blades

- Keine Original-Ersatzteile - Il ne s'agit pas de pièces originales - No genuine spare parts -

Ferrari FER-17R re/dr/ri FER-17L li/ga/le	Ferrari FER-21R re/dr/ri FER-21L li/ga/le	Ferrari FER-23R re/dr/ri FER-23L li/ga/le	Ferrari FER-25R re/dr/ri FER-25L li/ga/le
Orig.-Nr. / réf. origine / orig.-part-no.	Orig.-Nr. / réf. origine / orig.-part-no.	Orig.-Nr. / réf. origine / orig.-part-no.	Orig.-Nr. / réf. origine / orig.-part-no.
	63196 re/dr/ri 63195 li/ga/le	72	0305064115 re/dr/ri 0305064114 li/ga/le
Gewicht / poids / weight	Gewicht / poids / weight	Gewicht / poids / weight	Gewicht / poids / weight
0,580	0,350	0,400	0,230
Schraube M12x1,25x35 - 12.9 boulon / bolt	Schraube M10x1x35 - 10.9 boulon / bolt	Schraube M10x1x30 - 10.9 boulon / bolt	Schraube M10x1x35 - 10.9 boulon / bolt
30-1235	30-1035	30-1030	30-1035

Ferrari GRI-01R re/dr/ri GRI-01L li/ga/le	Ferrari PAB-02R re/dr/ri PAB-02L li/ga/le	Ferri FEI-01R re/dr/ri FEI-01L li/ga/le	Ferri & Simoni FES-01R re/dr/ri FES-01L li/ga/le
Orig.-Nr. / réf. origine / orig.-part-no.	Orig.-Nr. / réf. origine / orig.-part-no.	Orig.-Nr. / réf. origine / orig.-part-no.	Orig.-Nr. / réf. origine / orig.-part-no.
63200 re/dr/ri 63199 li/ga/le	34		
Gewicht / poids / weight	Gewicht / poids / weight	Gewicht / poids / weight	Gewicht / poids / weight
0,290	0,440	0,490	1,220
Schraube M10x1x35 - 10.9 boulon / bolt	Schraube M10x1x35 - 10.9 boulon / bolt		
30-1035	30-1035		

Fischgräbe IND-21R re/dr/ri IND-21L li/ga/le	Fischgräbe IND-101R re/dr/ri IND-101L li/ga/le	FM-Matras FMO-03R re/dr/ri FMO-03L li/ga/le	FM-Matras FMO-04R re/dr/ri FMO-04L li/ga/le
Orig.-Nr. / réf. origine / orig.-part-no.	Orig.-Nr. / réf. origine / orig.-part-no.	Orig.-Nr. / réf. origine / orig.-part-no.	Orig.-Nr. / réf. origine / orig.-part-no.
		S	R4L300
Gewicht / poids / weight	Gewicht / poids / weight	Gewicht / poids / weight	Gewicht / poids / weight
0,265	0,330	0,340	0,560
		Schraube M10x1x35 - 10.9 boulon / bolt	Schraube M10x1x35 - 10.9 boulon / bolt
		30-1035	30-1035

- Keine Original-Ersatzteile - Il ne s'agit pas de pièces originales - No genuine spare parts -

Maße und Gewichte annähernd und unverbindlich - Les mesures et poids sont approximatifs et sous réserve - Dimensions and weights are approximate and not binding
 Technische Änderungen vorbehalten - Modifications techniques réservées - Technical changes reserved



Original Muzzi-Fräsmesser mit Garantie / couteaux Muzzi avec garantie / Original warranted Muzzi Blades

Fräsmesser u. Rotorzinken nach Fabrikat:
 Couteaux et lames de rotalabour pour machines:
 Blades and knives for spike rotor to fit:

Technische Änderungen vorbehalten - Modifications techniques réservées - Technical changes reserved
 Maße und Gewichte annähernd und unverbindlich - Les mesures et poids sont approximatifs et sous réserve - Dimensions and weights are approximate and not binding

FM-Matras	
FMO-05R re/dr/ri	
FMO-05L li/ga/le	
Orig.-Nr. / réf. origine / orig.-part-no.	
R5R100	
Gewicht / poids / weight	0,500
Schraube M10x1x35 - 10.9 boulon / bolt	30-1035

FM-Matras	
FMO-11R re/dr/ri	
FMO-11L li/ga/le	
Orig.-Nr. / réf. origine / orig.-part-no.	
D7	
Gewicht / poids / weight	0,190

FM-Matras	
GOL-17R re/dr/ri	
GOL-17L li/ga/le	
Orig.-Nr. / réf. origine / orig.-part-no.	
MT14	
Gewicht / poids / weight	0,380

FM-Matras	
GOL-30R re/dr/ri	
GOL-30L li/ga/le	
Orig.-Nr. / réf. origine / orig.-part-no.	
MT10	
Gewicht / poids / weight	0,380

Forigo-Roteritalia	
FRG-03	
Orig.-Nr. / réf. origine / orig.-part-no.	
F4153011	
Gewicht / poids / weight	2,070

Forigo-Roteritalia	
FRG-04R re/dr/ri	
FRG-04L li/ga/le	
Orig.-Nr. / réf. origine / orig.-part-no.	
F2095010D re/dr/ri	
F2095010S li/ga/le	
Gewicht / poids / weight	0,740
Schraube M12x1,25x35 - 12.9 boulon / bolt	30-1235

Forigo-Roteritalia	
FRG-05R re/dr/ri	
FRG-05L li/ga/le	
Orig.-Nr. / réf. origine / orig.-part-no.	
F3156010 re/dr/ri	
F3156110 li/ga/le	
Gewicht / poids / weight	0,920
Schraube M14x1,5x40 - 12.9 boulon / bolt	30-1440

Forigo-Roteritalia	
FRG-06R re/dr/ri	
FRG-06L li/ga/le	
Orig.-Nr. / réf. origine / orig.-part-no.	
G2596010 re/dr/ri	
G2596011 li/ga/le	
Gewicht / poids / weight	0,790
Schraube M12x1,25x35 - 12.9 boulon / bolt	30-1235

Forigo-Roteritalia	
FRG-07R re/dr/ri	
FRG-07L li/ga/le	
Orig.-Nr. / réf. origine / orig.-part-no.	
G3596010 re/dr/ri	
G3596110 li/ga/le	
Gewicht / poids / weight	1,180
Schraube M14x1,5x40 - 12.9 boulon / bolt	30-1440

Forigo-Roteritalia	
FRG-13R re/dr/ri	
FRG-13L li/ga/le	
Orig.-Nr. / réf. origine / orig.-part-no.	
350010020 re/dr/ri	
350010030 li/ga/le	
Gewicht / poids / weight	0,630

Original Muzzi-Fräsmesser mit Garantie / couteaux Muzzi avec garantie / Original warranted Muzzi Blades

- Keine Original-Ersatzteile - Il ne s'agit pas de pièces originales - No genuine spare parts -

Fräsmesser u. Rotorzinken nach Fabrikat:
 Couteaux et lames de rotalabour pour machines:
 Blades and knives for spike rotor to fit:

Forigo-Roteritalia

FRG-16R re/dr/ri	
FRG-16L li/ga/le NEU	
Orig.-Nr. / réf. origine / orig.-part-no.	
G4595000 re/dr/ri	
G4595100 li/ga/le	
Gewicht / poids / weight	1,280

Forigo-Roteritalia

FRG-19R re/dr/ri	
FRG-19L li/ga/le NEU	
Orig.-Nr. / réf. origine / orig.-part-no.	
D450010020 re/dr/ri	
D450010030 li/ga/le	
Gewicht / poids / weight	1,450

Forigo-Roteritalia

FRG-21R re/dr/ri	
FRG-21L li/ga/le NEU	
Orig.-Nr. / réf. origine / orig.-part-no.	
D350010350 re/dr/ri	
D350010360 li/ga/le	
Gewicht / poids / weight	1,170

Forigo-Roteritalia

MAS-37R re/dr/ri	
MAS-37L li/ga/le	
Orig.-Nr. / réf. origine / orig.-part-no.	
Gewicht / poids / weight	
0,980	
Schraube M14x1,5x40 - 12.9 boulon / bolt	30-1440

Forigo-Roteritalia

SOV-05R re/dr/ri	
SOV-05L li/ga/le	
Orig.-Nr. / réf. origine / orig.-part-no.	
Gewicht / poids / weight	
0,820	
Schraube M12x1,25x35 - 12.9 boulon / bolt	30-1235

Fort

FOR-01R re/dr/ri	
FOR-01L li/ga/le	
Orig.-Nr. / réf. origine / orig.-part-no.	
Gewicht / poids / weight	
0,210	
Schraube M8x1x30 - 10.9 boulon / bolt	30-830

Fort

FOR-02R re/dr/ri	
FOR-02L li/ga/le	
Orig.-Nr. / réf. origine / orig.-part-no.	
Gewicht / poids / weight	
0,340	
Schraube M8x1x30 - 10.9 boulon / bolt	30-830

Fort

FOR-03R re/dr/ri	
FOR-03L li/ga/le	
Orig.-Nr. / réf. origine / orig.-part-no.	
Gewicht / poids / weight	
0,330	
Schraube M8x1x30 - 10.9 boulon / bolt	30-830

Fort

FOR-05R re/dr/ri	
FOR-05L li/ga/le	
Orig.-Nr. / réf. origine / orig.-part-no.	
Gewicht / poids / weight	
0,490	
Schraube M10x1x30 - 10.9 boulon / bolt	30-1030

Fort

FOR-06R re/dr/ri	
FOR-06L li/ga/le	
Orig.-Nr. / réf. origine / orig.-part-no.	
Gewicht / poids / weight	
0,440	
Schraube M10x1x30 - 10.9 boulon / bolt	30-1030

Fort

FOR-07R re/dr/ri	
FOR-07L li/ga/le	
Orig.-Nr. / réf. origine / orig.-part-no.	
Gewicht / poids / weight	
0,470	
Schraube M10x1x30 - 10.9 boulon / bolt	30-1030

- Keine Original-Ersatzteile - Il ne s'agit pas de pièces originales - No genuine spare parts -

Maße und Gewichte annähernd und unverbindlich - Les mesures et poids sont approximatifs et sous réserve - Dimensions and weights are approximate and not binding - Technische Änderungen vorbehalten - Modifications techniques réservées - Technical changes reserved



Original Muzzi-Fräsmesser mit Garantie / couteaux Muzzi avec garantie / Original warranted Muzzi Blades

Fräsmesser u. Rotorzinken nach Fabrikat:
 Couteaux et lames de rotalabour pour machines:
 Blades and knives for spike rotor to fit:

Technische Änderungen vorbehalten - Modifications techniques réservées - Technical changes reserved
 Maße und Gewichte annähernd und unverbindlich - Les mesures et poids sont approximatifs et sous réserve - Dimensions and weights are approximate and not binding

Fort
FOR-08R re/dr/ri
FOR-08L li/ga/le

Orig.-Nr. / réf. origine / orig.-part-no.

Gewicht / poids / weight	0,520
Schraube M10x1x30 - 10.9 boulon / bolt	30-1030

Fort
FOR-10R re/dr/ri
FOR-10L li/ga/le

Orig.-Nr. / réf. origine / orig.-part-no.

Gewicht / poids / weight	0,380
Schraube M10x1x30 - 10.9 boulon / bolt	30-1030

Fort
FOR-11R re/dr/ri
FOR-11L li/ga/le

Orig.-Nr. / réf. origine / orig.-part-no.

Gewicht / poids / weight	0,280
Schraube M8x1x30 - 10.9 boulon / bolt	30-830

Fort
FOR-14R re/dr/ri
FOR-14L li/ga/le **NEU**

Orig.-Nr. / réf. origine / orig.-part-no.

Gewicht / poids / weight	0,260
Schraube M8x1x30 - 10.9 boulon / bolt	30-830

Fort
FOR-21R re/dr/ri
FOR-21L li/ga/le **NEU**

Orig.-Nr. / réf. origine / orig.-part-no.

Gewicht / poids / weight	0,290
Schraube M8x1x30 - 10.9 boulon / bolt	30-830

Fort
GOL-29R re/dr/ri
GOL-29L li/ga/le

Orig.-Nr. / réf. origine / orig.-part-no.

Gewicht / poids / weight	0,610
Schraube M10x1x30 - 10.9 boulon / bolt	30-1030

Gaspardo
GAS-01

Orig.-Nr. / réf. origine / orig.-part-no.

Gewicht / poids / weight	0,610
--------------------------	-------

Gehring
IND-37R re/dr/ri
IND-37L li/ga/le

Orig.-Nr. / réf. origine / orig.-part-no.

Gewicht / poids / weight	0,850
--------------------------	-------

Gehring
IND-38

Orig.-Nr. / réf. origine / orig.-part-no.

Gewicht / poids / weight	0,860
--------------------------	-------

Gehring
IND-37A-R re/dr/ri
IND-37A-L li/ga/le

Orig.-Nr. / réf. origine / orig.-part-no.

Gewicht / poids / weight	0,900
--------------------------	-------

Goldoni
BRE-03R re/dr/ri
BRE-03L li/ga/le

Orig.-Nr. / réf. origine / orig.-part-no.

17011 re/dr/ri	
17012 li/ga/le	
Gewicht / poids / weight	0,680
Schraube M12x1,25x35 - 12.9 boulon / bolt	30-1235

Goldoni
GOL-01R re/dr/ri
GOL-01L li/ga/le

Orig.-Nr. / réf. origine / orig.-part-no.

2064 re/dr/ri	
2065 li/ga/le	
Gewicht / poids / weight	0,430
Schraube M12x1,25x35 - 12.9 boulon / bolt	30-1235



Original Muzzi-Fräsmesser mit Garantie / couteaux Muzzi avec garantie / Original warranted Muzzi Blades

- Keine Original-Ersatzteile - Il ne s'agit pas de pièces originales - No genuine spare parts -

Goldoni

GOL-03R re/dr/ri	
GOL-03L li/ga/le	
Orig.-Nr. / réf. origine / orig.-part-no.	
3935 re/dr/ri	
3936 li/ga/le	
Gewicht / poids / weight	0,700
Schraube M10x1x30 - 10.9 boulon / bolt	30-1030

Goldoni

GOL-07R re/dr/ri	
GOL-07L li/ga/le	
Orig.-Nr. / réf. origine / orig.-part-no.	
5624312 re/dr/ri	
5624265 li/ga/le	
Gewicht / poids / weight	0,510
Schraube M10x1x30 - 10.9 boulon / bolt	30-1030

Goldoni

GOL-11R re/dr/ri	
GOL-11L li/ga/le	
Orig.-Nr. / réf. origine / orig.-part-no.	
14191 re/dr/ri	
14192 li/ga/le	
Gewicht / poids / weight	0,340
Schraube M10x1x30 - 10.9 boulon / bolt	30-1030

Goldoni

GOL-15R re/dr/ri	
GOL-15L li/ga/le	
Orig.-Nr. / réf. origine / orig.-part-no.	
2070 re/dr/ri	
2071 li/ga/le	
Gewicht / poids / weight	0,330
Schraube M8x1x30 - 10.9 boulon / bolt	30-830

Goldoni

GOL-17R re/dr/ri	
GOL-17L li/ga/le	
Orig.-Nr. / réf. origine / orig.-part-no.	
9402 re/dr/ri	
9401 li/ga/le	
Gewicht / poids / weight	0,380
Schraube M10x1x30 - 10.9 boulon / bolt	30-1030

Goldoni

GOL-20R re/dr/ri	
GOL-20L li/ga/le	
Orig.-Nr. / réf. origine / orig.-part-no.	
0434 re/dr/ri	
0435 li/ga/le	
Gewicht / poids / weight	0,720
Schraube M10x1x30 - 10.9 boulon / bolt	30-1030

Goldoni

GOL-26R re/dr/ri	
GOL-26L li/ga/le	
Orig.-Nr. / réf. origine / orig.-part-no.	
002692 re/dr/ri	
002693 li/ga/le	
Gewicht / poids / weight	0,360
Schraube M10x1x30 - 10.9 boulon / bolt	30-1030

Goldoni

GOL-28R re/dr/ri	
GOL-28L li/ga/le	
Orig.-Nr. / réf. origine / orig.-part-no.	
9417 re/dr/ri	
9418 li/ga/le	
Gewicht / poids / weight	0,580
Schraube M10x1x30 - 10.9 boulon / bolt	30-1030

Goldoni

GOL-29R re/dr/ri	
GOL-29L li/ga/le	
Orig.-Nr. / réf. origine / orig.-part-no.	
5324 re/dr/ri	
5323 li/ga/le	
Gewicht / poids / weight	0,610
Schraube M10x1x30 - 10.9 boulon / bolt	30-1030

Goldoni

GOL-30R re/dr/ri	
GOL-30L li/ga/le	
Orig.-Nr. / réf. origine / orig.-part-no.	
8834 re/dr/ri	
8833 li/ga/le	
Gewicht / poids / weight	0,380
Schraube M10x1x30 - 10.9 boulon / bolt	30-1030

Goldoni

GOL-32R re/dr/ri	
GOL-32L li/ga/le	
Orig.-Nr. / réf. origine / orig.-part-no.	
13546 re/dr/ri	
13545 li/ga/le	
Gewicht / poids / weight	0,330
Schraube M10x1x30 - 10.9 boulon / bolt	30-1030

Goldoni

GOL-33R re/dr/ri	
GOL-33L li/ga/le	
Orig.-Nr. / réf. origine / orig.-part-no.	
9506 re/dr/ri	
9507 li/ga/le	
Gewicht / poids / weight	0,720
Schraube M12x1,25x35 - 12.9 boulon / bolt	30-1235

- Keine Original-Ersatzteile - Il ne s'agit pas de pièces originales - No genuine spare parts -

Maße und Gewichte annähernd und unverbindlich - Les mesures et poids sont approximatifs et sous réserve - Dimensions and weights are approximate and not binding - Technische Änderungen vorbehalten - Modifications techniques réservées - Technical changes reserved



Original Muzzi-Fräsmesser mit Garantie / couteaux Muzzi avec garantie / Original warranted Muzzi Blades

Fräsmesser u. Rotorzinken nach Fabrikat:
 Couteaux et lames de rotalabour pour machines:
 Blades and knives for spike rotor to fit:

Technische Änderungen vorbehalten - Modifications techniques réservées - Technical changes reserved
 Maße und Gewichte annähernd und unverbindlich - Les mesures et poids sont approximatifs et sous réserve - Dimensions and weights are approximate and not binding

Goldoni	Goldoni	Goldoni	Goldoni
GOL-34R re/dr/ri	GOL-35R re/dr/ri	GOL-37R re/dr/ri	GOL-38R re/dr/ri
GOL-34L li/ga/le	GOL-35L li/ga/le	GOL-37L li/ga/le NEU	GOL-38L li/ga/le
Orig.-Nr. / réf. origine / orig.-part-no. 14486 re/dr/ri 14487 li/ga/le	Orig.-Nr. / réf. origine / orig.-part-no. 15231 re/dr/ri 15232 li/ga/le	Orig.-Nr. / réf. origine / orig.-part-no. 0008831 re/dr/ri 0008832 li/ga/le	Orig.-Nr. / réf. origine / orig.-part-no. 20136 re/dr/ri 20137 li/ga/le
Gewicht / poids / weight 0,400	Gewicht / poids / weight 0,580	Gewicht / poids / weight 0,210	Gewicht / poids / weight 0,620
Schraube M10x1x35 - 10.9 30-1035 boulon / bolt	Schraube M12x1,25x35 - 12.9 30-1235 boulon / bolt	Schraube M10x1x30 - 10.9 30-1030 boulon / bolt	Schraube M12x1,25x35 - 12.9 30-1235 boulon / bolt

Goldoni	Goldoni	Gramegna
GOL-39R re/dr/ri	GOL-53R re/dr/ri	GRA-01R re/dr/ri
GOL-39L li/ga/le	GOL-53L li/ga/le	GRA-01L li/ga/le
Orig.-Nr. / réf. origine / orig.-part-no. 4312 re/dr/ri 4313 li/ga/le	Orig.-Nr. / réf. origine / orig.-part-no. 17011 re/dr/ri 17012 li/ga/le	Orig.-Nr. / réf. origine / orig.-part-no.
Gewicht / poids / weight 0,490	Gewicht / poids / weight 0,620	Gewicht / poids / weight 1,070
Schraube M10x1x30 - 10.9 30-1030 boulon / bolt	Schraube M12x1,25x35 - 12.9 30-1235 boulon / bolt	Schraube M12x1,25x35 - 12.9 30-1235 boulon / bolt

Grillo (Pinza)	Grillo (Pinza)	Grillo (Pinza)	Grillo (Pinza)
BCS-01R re/dr/ri	BEN-43R re/dr/ri	GRI-01R re/dr/ri	GRI-04R re/dr/ri
BCS-01L li/ga/le	BEN-43L li/ga/le	GRI-01L li/ga/le	GRI-04L li/ga/le
Orig.-Nr. / réf. origine / orig.-part-no. 43432 re/dr/ri 43431 li/ga/le	Orig.-Nr. / réf. origine / orig.-part-no.	Orig.-Nr. / réf. origine / orig.-part-no. 7085 re/dr/ri 7086 li/ga/le	Orig.-Nr. / réf. origine / orig.-part-no. 7087 re/dr/ri 7088 li/ga/le
Gewicht / poids / weight 0,200	Gewicht / poids / weight 0,180	Gewicht / poids / weight 0,290	Gewicht / poids / weight 0,220
Schraube M8x1x30 - 10.9 30-830 boulon / bolt	Schraube M8x1x30 - 10.9 30-830 boulon / bolt	Schraube M10x1x35 - 10.9 30-1035 boulon / bolt	Schraube M8x1x30 - 10.9 30-830 boulon / bolt



Original Muzzi-Fräsmesser mit Garantie / couteaux Muzzi avec garantie / Original warranted Muzzi Blades

- Keine Original-Ersatzteile - Il ne s'agit pas de pièces originales - No genuine spare parts -

Grillo (Pinza)

GRI-06R re/dr/ri	
GRI-06L li/ga/le	
Orig.-Nr. / réf. origine / orig.-part-no.	
7635 re/dr/ri	
7636 li/ga/le	
Gewicht / poids / weight	0,370
Schraube M10x1x30 - 10.9 boulon / bolt	30-1030

Grillo (Pinza)

GRI-08R re/dr/ri	
GRI-08L li/ga/le	
Orig.-Nr. / réf. origine / orig.-part-no.	
9253 re/dr/ri	
9254 li/ga/le	
Gewicht / poids / weight	0,470
Schraube M10x1x35 - 10.9 boulon / bolt	30-1035

Grillo (Pinza)

GRI-09R re/dr/ri	
GRI-09L li/ga/le	
Orig.-Nr. / réf. origine / orig.-part-no.	
11293 re/dr/ri	
11294 li/ga/le	
Gewicht / poids / weight	0,340
Schraube M10x1x35 - 10.9 boulon / bolt	30-1035

Grillo (Pinza)

GRI-11R re/dr/ri	
GRI-11L li/ga/le	
Orig.-Nr. / réf. origine / orig.-part-no.	
10203 re/dr/ri	
10204 li/ga/le	
Gewicht / poids / weight	0,320
Schraube M8x1x30 - 10.9 boulon / bolt	30-830

Grillo (Pinza)

GRI-12R re/dr/ri	
GRI-12L li/ga/le	
Orig.-Nr. / réf. origine / orig.-part-no.	
21385 re/dr/ri	
21386 li/ga/le	
Gewicht / poids / weight	0,400
Schraube M10x1x35 - 10.9 boulon / bolt	30-1035

Grillo (Pinza)

GRI-17R re/dr/ri	
GRI-17L li/ga/le	
Orig.-Nr. / réf. origine / orig.-part-no.	
28035 re/dr/ri	
28036 li/ga/le	
Gewicht / poids / weight	0,170
Schraube M8x1x30 - 10.9 boulon / bolt	30-830

Grillo (Pinza)

GRI-21R re/dr/ri	
GRI-21L li/ga/le	
Orig.-Nr. / réf. origine / orig.-part-no.	
48170 re/dr/ri	
48171 li/ga/le	
Gewicht / poids / weight	0,350
Schraube M8x1x30 - 10.9 boulon / bolt	30-830

Gutbrod

GUT-51R re/dr/ri	
GUT-51L li/ga/le	
Orig.-Nr. / réf. origine / orig.-part-no.	
75.73.026 re/dr/ri	
75.73.027 li/ga/le	
Gewicht / poids / weight	0,290

Gutbrod

GUT-51-AR re/dr/ri	
GUT-51-AL li/ga/le	
Orig.-Nr. / réf. origine / orig.-part-no.	
Gewicht / poids / weight	0,220

Gutbrod

GUT-52R re/dr/ri	
GUT-52L li/ga/le	
Orig.-Nr. / réf. origine / orig.-part-no.	
75.71.062 re/dr/ri	
75.71.063 li/ga/le	
Gewicht / poids / weight	0,120

Gutbrod

IND-136R re/dr/ri	
IND-136L li/ga/le	
Orig.-Nr. / réf. origine / orig.-part-no.	
071.73.120 re/dr/ri	
071.73.121 li/ga/le	
Gewicht / poids / weight	0,280

- Keine Original-Ersatzteile - Il ne s'agit pas de pièces originales - No genuine spare parts -

Maße und Gewichte annähernd und unverbindlich - Les mesures et poids sont approximatifs et sous réserve - Dimensions and weights are approximate and not binding
 Technische Änderungen vorbehalten - Modifications techniques réservées - Technical changes reserved



Original Muzzi-Fräsmesser mit Garantie / couteaux Muzzi avec garantie / Original warranted Muzzi Blades

Fräsmesser u. Rotorzinken nach Fabrikat:
 Couteaux et lames de rotalabour pour machines:
 Blades and knives for spike rotor to fit:

Technische Änderungen vorbehalten - Modifications techniques réservées - Technical changes reserved
 Maße und Gewichte annähernd und unverbindlich - Les mesures et poids sont approximatifs et sous réserve - Dimensions and weights are approximate and not binding

Hako	
HAK-01R re/dr/ri	
HAK-01L li/ga/le	
Orig.-Nr. / réf. origine / orig.-part-no.	
90-05836-3 re/dr/ri	
90-05837-1 li/ga/le	
Gewicht / poids / weight	0,340
Schraube M8x1x30 - 10.9 boulon / bolt	30-830

Hako	
HAK-51R re/dr/ri	
HAK-51L li/ga/le	
Orig.-Nr. / réf. origine / orig.-part-no.	
E0142-10 re/dr/ri	
E0143-11 li/ga/le	
Gewicht / poids / weight	0,260
Schraube M8x1x30 - 10.9 boulon / bolt	30-830

Hako	
HAK-56R re/dr/ri	
HAK-56L li/ga/le	
Orig.-Nr. / réf. origine / orig.-part-no.	
90-00978/8	
Gewicht / poids / weight	0,180
Schraube	

Holder	
HOL-01R re/dr/ri	
HOL-01L li/ga/le	
Orig.-Nr. / réf. origine / orig.-part-no.	
1832442310 re/dr/ri	
1832442210 li/ga/le	
Gewicht / poids / weight	0,750
Schraube M12x1,25x35 - 12.9 boulon / bolt	30-1235

Holder	
HOL-03R re/dr/ri	
HOL-03L li/ga/le	
Orig.-Nr. / réf. origine / orig.-part-no.	
13832440110 re/dr/ri	
13832440010 li/ga/le	
Gewicht / poids / weight	0,400
Schraube M8x1x30 - 10.9 boulon / bolt	30-830

Holder	
HOL-04R re/dr/ri	
HOL-04L li/ga/le	
Orig.-Nr. / réf. origine / orig.-part-no.	
5032420510 re/dr/ri	
5032420410 li/ga/le	
Gewicht / poids / weight	0,180
Schraube M8x1x30 - 10.9 boulon / bolt	30-830

Holder	
HOL-05R re/dr/ri	
HOL-05L li/ga/le	
Orig.-Nr. / réf. origine / orig.-part-no.	
2832440010 re/dr/ri	
2832440110 li/ga/le	
Gewicht / poids / weight	0,180
Schraube	

Holder	
HOL-57R re/dr/ri	
HOL-57L li/ga/le	
Orig.-Nr. / réf. origine / orig.-part-no.	
1832440510 re/dr/ri	
1832440610 li/ga/le	
Gewicht / poids / weight	0,930
Schraube	

Honda	
HON-01R re/dr/ri	
HON-01L li/ga/le	
Orig.-Nr. / réf. origine / orig.-part-no.	
F400/80	
Gewicht / poids / weight	0,300
Schraube M8x1x30 - 10.9 boulon / bolt	30-830

Honda	
HON-02R re/dr/ri	
HON-02L li/ga/le	
Orig.-Nr. / réf. origine / orig.-part-no.	
F600/80	
Gewicht / poids / weight	0,250
Schraube M8x1x30 - 10.9 boulon / bolt	30-830

Honda	
HON-03R re/dr/ri	
HON-03L li/ga/le	
Orig.-Nr. / réf. origine / orig.-part-no.	
F300	
Gewicht / poids / weight	0,240
Schraube M8x1x30 - 10.9 boulon / bolt	30-830

Honda	
HON-05R re/dr/ri	
HON-05L li/ga/le	
Orig.-Nr. / réf. origine / orig.-part-no.	
501	
Gewicht / poids / weight	0,350
Schraube	

Original Muzzi-Fräsmesser mit Garantie / couteaux Muzzi avec garantie / Original warranted Muzzi Blades

- Keine Original-Ersatzteile - Il ne s'agit pas de pièces originales - No genuine spare parts -

Honda	
HON-06R re/dr/ri	
HON-06L li/ga/le	
Orig.-Nr. / réf. origine / orig.-part-no.	
510-560	
Gewicht / poids / weight	0,350
Schraube M8x1x30 - 10.9 boulon / bolt	
30-830	

Honda	
HON-09R re/dr/ri	
HON-09L li/ga/le	
Orig.-Nr. / réf. origine / orig.-part-no.	
F28/AD-CDF28/S	
Gewicht / poids / weight	0,200
Schraube M8x1x30 - 10.9 boulon / bolt	
30-830	

Honda	
HON-10R re/dr/ri	
HON-10L li/ga/le	
Orig.-Nr. / réf. origine / orig.-part-no.	
F50/65	
Gewicht / poids / weight	0,240
Schraube M8x1x30 - 10.9 boulon / bolt	
30-830	

Honda	
HON-12R re/dr/ri	
HON-12L li/ga/le	
Orig.-Nr. / réf. origine / orig.-part-no.	
F300	
Gewicht / poids / weight	0,290
Schraube M8x1x30 - 10.9 boulon / bolt	
30-830	

Honda	
HON-13R re/dr/ri	
HON-13L li/ga/le	
Orig.-Nr. / réf. origine / orig.-part-no.	
F.201	
Gewicht / poids / weight	0,160
Schraube M8x1x30 - 10.9 boulon / bolt	
30-830	

Howard	
HOW-01R re/dr/ri	
HOW-01L li/ga/le	
Orig.-Nr. / réf. origine / orig.-part-no.	
9954 re/dr/ri	
9953 li/ga/le	
Gewicht / poids / weight	0,840
Schraube 7/16"UNFx32 - 12.9 boulon / bolt	
30-71632	

Howard	
HOW-02R re/dr/ri	
HOW-02L li/ga/le	
Orig.-Nr. / réf. origine / orig.-part-no.	
9901 (9924) re/dr/ri	
9900 (9923) li/ga/le	
Gewicht / poids / weight	0,840
Schraube 7/16"UNFx32 - 12.9 boulon / bolt	
30-71632	

Howard	
HOW-03R re/dr/ri	
HOW-03L li/ga/le	
Orig.-Nr. / réf. origine / orig.-part-no.	
9949 (9931) re/dr/ri	
9948 (9930) li/ga/le	
Gewicht / poids / weight	1,000
Schraube 1/2"UNFx38 - 12.9 boulon / bolt	
30-3903	

Howard	
HOW-04R re/dr/ri	
HOW-04L li/ga/le	
Orig.-Nr. / réf. origine / orig.-part-no.	
3901 (63593) re/dr/ri	
3900 (63592) li/ga/le	
Gewicht / poids / weight	0,850
Schraube 1/2"UNFx38 - 12.9 boulon / bolt	
30-3903	

Howard	
HOW-05R re/dr/ri	
HOW-05L li/ga/le	
Orig.-Nr. / réf. origine / orig.-part-no.	
Gewicht / poids / weight	1,150
Schraube 1/2"UNFx38 - 12.9 boulon / bolt	
30-3903	

Howard	
HOW-06R re/dr/ri	
HOW-06L li/ga/le	
Orig.-Nr. / réf. origine / orig.-part-no.	
Gewicht / poids / weight	1,150
Schraube 1/2"UNFx38 - 12.9 boulon / bolt	
30-3903	

Howard	
HOW-07R re/dr/ri	
HOW-07L li/ga/le	
Orig.-Nr. / réf. origine / orig.-part-no.	
9942 re/dr/ri	
9941 li/ga/le	
Gewicht / poids / weight	0,780
Schraube 7/16"UNFx40 - 12.9 boulon / bolt	
30-71640	

- Keine Original-Ersatzteile - Il ne s'agit pas de pièces originales - No genuine spare parts -

Maße und Gewichte annähernd und unverbindlich - Les mesures et poids sont approximatifs et sous réserve - Dimensions and weights are approximate and not binding - Technische Änderungen vorbehalten - Modifications techniques réservées - Technical changes reserved



Original Muzzi-Fräsmesser mit Garantie / couteaux Muzzi avec garantie / Original warranted Muzzi Blades

Fräsmesser u. Rotorzinken nach Fabrikat:
 Couteaux et lames de rotalabour pour machines:
 Blades and knives for spike rotor to fit:

Technische Änderungen vorbehalten - Modifications techniques réservées - Technical changes reserved
 Maße und Gewichte annähernd und unverbindlich - Les mesures et poids sont approximatifs et sous réserve - Dimensions and weights are approximate and not binding

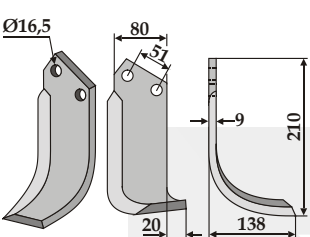
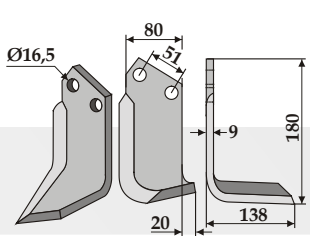
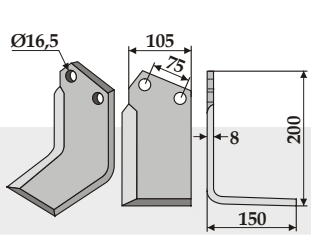
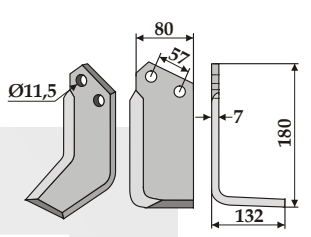
Howard HOW-08R re/dr/ri HOW-08L li/ga/le  Orig.-Nr. / réf. origine / orig.-part-no. 9951 re/dr/ri 9950 li/ga/le Gewicht / poids / weight 1,350	Howard HOW-09R re/dr/ri HOW-09L li/ga/le  Orig.-Nr. / réf. origine / orig.-part-no. 9863 (9920) re/dr/ri 9862 (9919) li/ga/le Gewicht / poids / weight 1,350 Schraube M16x1,5x47 - 12.9 30-1647 boulon / bolt	Howard HOW-10R re/dr/ri HOW-10L li/ga/le  Orig.-Nr. / réf. origine / orig.-part-no. 756784 (762719) re/dr/ri 756785 (762720) li/ga/le Gewicht / poids / weight 1,700 Schraube M16x1,5x47 - 12.9 30-1647 boulon / bolt	Howard HOW-11R re/dr/ri HOW-11L li/ga/le  Orig.-Nr. / réf. origine / orig.-part-no. 624400 re/dr/ri 624401 li/ga/le Gewicht / poids / weight 1,000 Schraube 7/16"UNFx35 - 12.9 30-71635 boulon / bolt
---------------------------------------------------------------------------------------------------------------------------------------------------------------------------------------------------------------------------------------------------------------------------	------------------------------------------------------------------------------------------------------------------------------------------------------------------------------------------------------------------------------------------------------------------------------------------------------------------------------------------------	---------------------------------------------------------------------------------------------------------------------------------------------------------------------------------------------------------------------------------------------------------------------------------------------------------------------------------------------------------	------------------------------------------------------------------------------------------------------------------------------------------------------------------------------------------------------------------------------------------------------------------------------------------------------------------------------------------

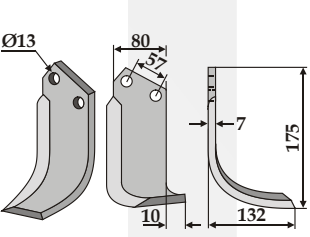
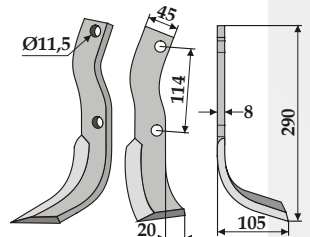
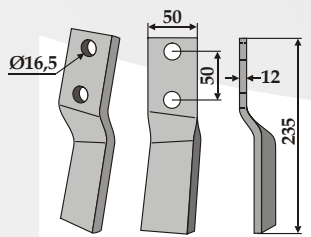
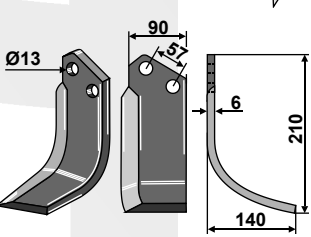
Howard HOW-12R re/dr/ri HOW-12L li/ga/le  Orig.-Nr. / réf. origine / orig.-part-no. 994881 re/dr/ri 994981 li/ga/le Gewicht / poids / weight 0,950 Schraube 1/2"UNFx38 - 12.9 30-3903 boulon / bolt	Howard HOW-14R re/dr/ri HOW-14L li/ga/le  Orig.-Nr. / réf. origine / orig.-part-no. 626090 (624399) re/dr/ri 626093 (624398) li/ga/le Gewicht / poids / weight 0,870 Schraube 7/16"UNFx40 - 12.9 30-71640 boulon / bolt	Howard HOW-15R re/dr/ri HOW-15L li/ga/le  Orig.-Nr. / réf. origine / orig.-part-no. 762407 re/dr/ri 762406 li/ga/le Gewicht / poids / weight 1,030 Schraube M16x1,5x52 - 12.9 30-1652 boulon / bolt	Howard HOW-16R re/dr/ri HOW-16L li/ga/le  Orig.-Nr. / réf. origine / orig.-part-no. 9949 re/dr/ri 9948 li/ga/le Gewicht / poids / weight 0,950 Schraube 1/2"UNFx38 - 12.9 30-3903 boulon / bolt
---------------------------------------------------------------------------------------------------------------------------------------------------------------------------------------------------------------------------------------------------------------------------------------------------------------------------------------	-----------------------------------------------------------------------------------------------------------------------------------------------------------------------------------------------------------------------------------------------------------------------------------------------------------------------------------------------------------	----------------------------------------------------------------------------------------------------------------------------------------------------------------------------------------------------------------------------------------------------------------------------------------------------------------------------------------	-------------------------------------------------------------------------------------------------------------------------------------------------------------------------------------------------------------------------------------------------------------------------------------------------------------------------------------

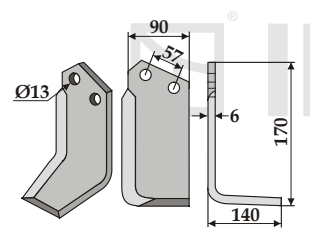
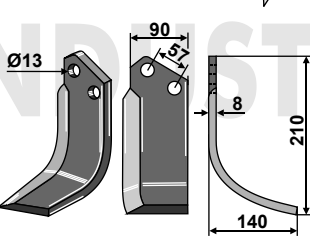
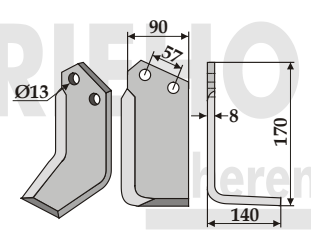
Howard HOW-17R re/dr/ri HOW-17L li/ga/le  Orig.-Nr. / réf. origine / orig.-part-no. 3901 re/dr/ri 3900 li/ga/le Gewicht / poids / weight 1,080 Schraube 1/2"UNFx38 - 12.9 30-3903 boulon / bolt	Howard HOW-18R re/dr/ri HOW-18L li/ga/le  Orig.-Nr. / réf. origine / orig.-part-no. 4439/610769 re/dr/ri 4439/610768 li/ga/le Gewicht / poids / weight 0,950 Schraube 1/2"UNFx38 - 12.9 30-3903 boulon / bolt	Howard HOW-19R re/dr/ri HOW-19L li/ga/le  Orig.-Nr. / réf. origine / orig.-part-no. 63605 re/dr/ri 63604 li/ga/le Gewicht / poids / weight 1,300 Schraube 1/2"UNFx38 - 12.9 30-3903 boulon / bolt
------------------------------------------------------------------------------------------------------------------------------------------------------------------------------------------------------------------------------------------------------------------------------------------------------------------------------------	--------------------------------------------------------------------------------------------------------------------------------------------------------------------------------------------------------------------------------------------------------------------------------------------------------------------------------------------------	---------------------------------------------------------------------------------------------------------------------------------------------------------------------------------------------------------------------------------------------------------------------------------------------------------------------------------------

 **Original Muzzi-Fräsmesser mit Garantie / couteaux Muzzi avec garantie / Original warranted Muzzi Blades**

- Keine Original-Ersatzteile - Il ne s'agit pas de pièces originales - No genuine spare parts

Howard

HOW-20R re/dr/ri	
HOW-20L li/ga/le	
Orig.-Nr. / réf. origine / orig.-part-no.	
9951 re/dr/ri	
9950 li/ga/le	
Gewicht / poids / weight	1,330
Schraube M16x1,5x47 - 12.9 boulon / bolt	30-1647

Howard

HOW-21R re/dr/ri	
HOW-21L li/ga/le	
Orig.-Nr. / réf. origine / orig.-part-no.	
9863 re/dr/ri	
9862 li/ga/le	
Gewicht / poids / weight	1,330
Schraube M16x1,5x52 - 12.9 boulon / bolt	30-1652

Howard

HOW-22R re/dr/ri	
HOW-22L li/ga/le	
Orig.-Nr. / réf. origine / orig.-part-no.	
9877 re/dr/ri	
9876 li/ga/le	
Gewicht / poids / weight	0,710
Schraube 7/16" UNFx35 - 12.9 boulon / bolt	30-71635

Howard

HOW-31R re/dr/ri	
HOW-31L li/ga/le	
Orig.-Nr. / réf. origine / orig.-part-no.	
63593 re/dr/ri	
63592 li/ga/le	
Gewicht / poids / weight	1,060
Schraube 1/2" UNFx38 - 12.9 boulon / bolt	30-3903

Howard

HOW-33R re/dr/ri	
HOW-33L li/ga/le	
Orig.-Nr. / réf. origine / orig.-part-no.	
9911 re/dr/ri	
9910 li/ga/le	
Gewicht / poids / weight	1,580

Howard

HOW-34R re/dr/ri	
HOW-34L li/ga/le	
Orig.-Nr. / réf. origine / orig.-part-no.	
5979 re/dr/ri	
5978 li/ga/le	
Gewicht / poids / weight	1,300
Schraube 1/2" UNFx38 - 12.9 boulon / bolt	30-3903

Howard

HOW-37R re/dr/ri	
HOW-37L li/ga/le	
Orig.-Nr. / réf. origine / orig.-part-no.	
653257 re/dr/ri	
653256 li/ga/le	
Gewicht / poids / weight	1,250
Schraube M16x1,5x52 - 12.9 boulon / bolt	30-1652

Howard

HOW-40R re/dr/ri	
HOW-40L li/ga/le	
Orig.-Nr. / réf. origine / orig.-part-no.	
647255 re/dr/ri	
647254 li/ga/le	
Gewicht / poids / weight	0,900
Schraube M16x1,5x52 - 12.9 boulon / bolt	30-1652

Howard

HOW-43R re/dr/ri	
HOW-43L li/ga/le	
Orig.-Nr. / réf. origine / orig.-part-no.	
653829 re/dr/ri	
653828 li/ga/le	
Gewicht / poids / weight	1,250

Howard

HOW-52R re/dr/ri	
HOW-52L li/ga/le	
Orig.-Nr. / réf. origine / orig.-part-no.	
184216 re/dr/ri	
184215 li/ga/le	
Gewicht / poids / weight	1,140

Howard

HOW-53R re/dr/ri	
HOW-53L li/ga/le	
Orig.-Nr. / réf. origine / orig.-part-no.	
181744 re/dr/ri	
181743 li/ga/le	
Gewicht / poids / weight	1,300

- Keine Original-Ersatzteile - Il ne s'agit pas de pièces originales - No genuine spare parts -

Maße und Gewichte annähernd und unverbindlich - Les mesures et poids sont approximatifs et sous réserve - Dimensions and weights are approximate and not binding - Technische Änderungen vorbehalten - Modifications techniques réservées - Technical changes reserved



Original Muzzi-Fräsmesser mit Garantie / couteaux Muzzi avec garantie / Original warranted Muzzi Blades

Fräsmesser u. Rotorzinken nach Fabrikat:
 Couteaux et lames de rotalabour pour machines:
 Blades and knives for spike rotor to fit:

Technische Änderungen vorbehalten - Modifications techniques réservées - Technical changes reserved
 Maße und Gewichte annähernd und unverbindlich - Les mesures et poids sont approximatifs et sous réserve - Dimensions and weights are approximate and not binding

Howard	
HOW-54R re/dr/ri	
HOW-54L li/ga/le	
Orig.-Nr. / réf. origine / orig.-part-no.	
181746 re/dr/ri	
181745 li/ga/le	
Gewicht / poids / weight	1,490
Schraube M14x1,5x40 - 12.9 boulon / bolt	
30-1440	

Howard	
HOW-88R re/dr/ri	
HOW-88L li/ga/le	
Orig.-Nr. / réf. origine / orig.-part-no.	
103524 re/dr/ri	
103523 li/ga/le	
Gewicht / poids / weight	1,800
Schraube M14x1,5x40 - 12.9 boulon / bolt	
30-1440	

Huard	
HUA-01R re/dr/ri	
HUA-01L li/ga/le	
Orig.-Nr. / réf. origine / orig.-part-no.	
226090 re/dr/ri	
226091 li/ga/le	
Gewicht / poids / weight	1,100
Schraube M14x1,5x40 - 12.9 boulon / bolt	
30-1440	

Huard	
HUA-03R re/dr/ri	
HUA-03L li/ga/le	
Orig.-Nr. / réf. origine / orig.-part-no.	
226096 re/dr/ri	
226097 li/ga/le	
Gewicht / poids / weight	1,100
Schraube M14x1,5x40 - 12.9 boulon / bolt	
30-1440	

Huard	
HOW-10R re/dr/ri	
HOW-10L li/ga/le	
Orig.-Nr. / réf. origine / orig.-part-no.	
756784 (762719) re/dr/ri	
756785 (762720) li/ga/le	
Gewicht / poids / weight	1,700
Schraube M16x1,5x47 - 12.9 boulon / bolt	
30-1647	

Iseki	
BCS-01R re/dr/ri	
BCS-01L li/ga/le	
Orig.-Nr. / réf. origine / orig.-part-no.	
IM-210579 re/dr/ri	
IM-210578 li/ga/le	
Gewicht / poids / weight	0,400
Schraube M8x1x30 - 10.9 boulon / bolt	
30-830	

Iseki	
ISE-01R re/dr/ri	
ISE-01L li/ga/le	
Orig.-Nr. / réf. origine / orig.-part-no.	
1349-716-0020-1 re/dr/ri	
1349-716-0010-1 li/ga/le	
Gewicht / poids / weight	0,350
Schraube M8x1x30 - 10.9 boulon / bolt	
30-830	

JNC	
JNC-01R re/dr/ri	
JNC-01L li/ga/le	
Orig.-Nr. / réf. origine / orig.-part-no.	
Gewicht / poids / weight	
0,695	
Schraube M12x1,25x40 - 12.9 boulon / bolt	
30-1240	

JNC	
JNC-02R re/dr/ri	
JNC-02L li/ga/le	
Orig.-Nr. / réf. origine / orig.-part-no.	
Gewicht / poids / weight	
0,700	
Schraube M12x1,25x40 - 12.9 boulon / bolt	
30-1240	

JNC	
JNC-03R re/dr/ri	
JNC-03L li/ga/le	
Orig.-Nr. / réf. origine / orig.-part-no.	
Gewicht / poids / weight	
0,670	
Schraube M12x1,25x40 - 12.9 boulon / bolt	
30-1240	

JNC	
JNC-04R re/dr/ri	
JNC-04L li/ga/le	
Orig.-Nr. / réf. origine / orig.-part-no.	
Gewicht / poids / weight	
0,760	
Schraube M12x1,25x40 - 12.9 boulon / bolt	
30-1240	

Original Muzzi-Fräsmesser mit Garantie / couteaux Muzzi avec garantie / Original warranted Muzzi Blades

- Keine Original-Ersatzteile - Il ne s'agit pas de pièces originales - No genuine spare parts -

Fräsmesser u. Rotorzinken nach Fabrikat:
 Couteaux et lames de rotalabour pour machines:
 Blades and knives for spike rotor to fit:

JNC	
JNC-05R re/dr/ri	
JNC-05L li/ga/le	
Orig.-Nr. / réf. origine / orig.-part-no.	
Gewicht / poids / weight 0,800	
Schraube M12x1,25x40 - 12.9 boulon / bolt	30-1240

Kongskilde	
KON-01	
Orig.-Nr. / réf. origine / orig.-part-no.	
Gewicht / poids / weight 0,900	

Krone	
CEL-07R re/dr/ri	
CEL-07L li/ga/le	
Orig.-Nr. / réf. origine / orig.-part-no.	
Gewicht / poids / weight 0,980	

Krone	
KRO-01R re/dr/ri	
KRO-01L li/ga/le	
Orig.-Nr. / réf. origine / orig.-part-no.	
0340200 re/dr/ri	
0341090 li/ga/le	
Gewicht / poids / weight 0,760	
Schraube M12x1,25x35 - 12.9 boulon / bolt	30-1235

Krone	
KRO-02R re/dr/ri	
KRO-02L li/ga/le	
Orig.-Nr. / réf. origine / orig.-part-no.	
0352681 re/dr/ri	
0354390 li/ga/le	
Gewicht / poids / weight 0,760	
Schraube M14x1,5x35 - 12.9 boulon / bolt	30-1435

Krone	
KRO-04R re/dr/ri	
KRO-04L li/ga/le	
Orig.-Nr. / réf. origine / orig.-part-no.	
0362730 re/dr/ri	
0363950 li/ga/le	
Gewicht / poids / weight 1,000	
Schraube M14x1,5x40 - 12.9 boulon / bolt	30-1440

Krone	
KRO-05R re/dr/ri	
KRO-05L li/ga/le	
Orig.-Nr. / réf. origine / orig.-part-no.	
1070830 re/dr/ri	
1072690 li/ga/le	
Gewicht / poids / weight 1,600	
Schraube M16x1,5x40 - 12.9 boulon / bolt	30-1640

Krone	
KRO-06	
Orig.-Nr. / réf. origine / orig.-part-no.	
Gewicht / poids / weight 1,000	

Krone	
KRO-07	
Orig.-Nr. / réf. origine / orig.-part-no.	
Gewicht / poids / weight 1,000	

Krone	
KRO-52R re/dr/ri	
KRO-52L li/ga/le	
Orig.-Nr. / réf. origine / orig.-part-no.	
35-32-40-1	
Gewicht / poids / weight 1,000	
Schraube M16x1,5x40 - 12.9 boulon / bolt	30-1640

Krone	
RH82	
Orig.-Nr. / réf. origine / orig.-part-no.	
514319.0	
Gewicht / poids / weight 1,200	

Krone	
RH107	
Orig.-Nr. / réf. origine / orig.-part-no.	
514319.2	
Gewicht / poids / weight 1,200	

- Keine Original-Ersatzteile - Il ne s'agit pas de pièces originales - No genuine spare parts -

Maße und Gewichte annähernd und unverbindlich - Les mesures et poids sont approximatifs et sous réserve - Dimensions and weights are approximate and not binding - Technische Änderungen vorbehalten - Modifications techniques réservées - Technical changes reserved



Original Muzzi-Fräsmesser mit Garantie / couteaux Muzzi avec garantie / Original warranted Muzzi Blades

Fräsmesser u. Rotorzinken nach Fabrikat:
 Couteaux et lames de rotalabour pour machines:
 Blades and knives for spike rotor to fit:

Technische Änderungen vorbehalten - Modifications techniques réservées - Technical changes reserved
 Maße und Gewichte annähernd und unverbindlich - Les mesures et poids sont approximatifs et sous réserve - Dimensions and weights are approximate and not binding

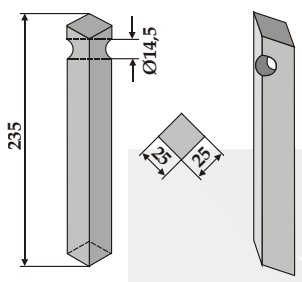
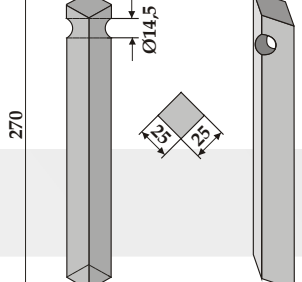
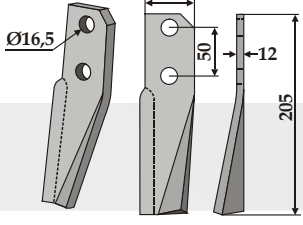
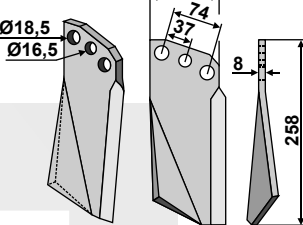
Krone RH-501  Orig.-Nr. / réf. origine / orig.-part-no. 514486-1 Gewicht / poids / weight 1,010	Krone RH-502  Orig.-Nr. / réf. origine / orig.-part-no. 107403-0 Gewicht / poids / weight 1,210	Kuhn KUH-01R re/dr/ri KUH-01L li/ga/le  Orig.-Nr. / réf. origine / orig.-part-no. 519165 re/dr/ri 519166 li/ga/le Gewicht / poids / weight 0,800	Kuhn KUH-03R re/dr/ri KUH-03L li/ga/le  Orig.-Nr. / réf. origine / orig.-part-no. 522602 re/dr/ri 522603 li/ga/le Gewicht / poids / weight 1,450
---------------------------------------------------------------------------------------------------------------------------------------------------------------------------------------------------------------	---------------------------------------------------------------------------------------------------------------------------------------------------------------------------------------------------------------	------------------------------------------------------------------------------------------------------------------------------------------------------------------------------------------------------------------------------------------------------------------------------	-------------------------------------------------------------------------------------------------------------------------------------------------------------------------------------------------------------------------------------------------------------------------------

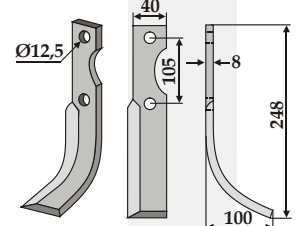
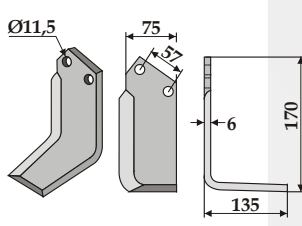
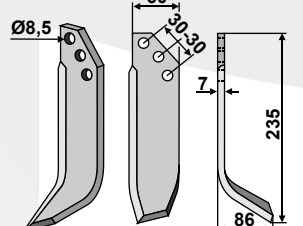
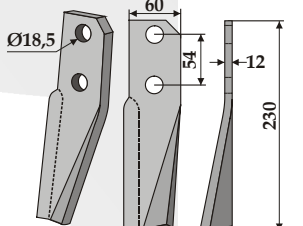
Kuhn KUH-06R re/dr/ri KUH-06L li/ga/le  Orig.-Nr. / réf. origine / orig.-part-no. 520115 re/dr/ri 520116 li/ga/le Gewicht / poids / weight 0,700	Kuhn KUH-12R re/dr/ri KUH-12L li/ga/le  Orig.-Nr. / réf. origine / orig.-part-no. 521063 re/dr/ri 521064 li/ga/le Gewicht / poids / weight 0,740 Schraube 7/16" UNF x 35 - 12.9 30-71635 boulon / bolt	Kuhn KUH-14R re/dr/ri KUH-14L li/ga/le  Orig.-Nr. / réf. origine / orig.-part-no. 596031 re/dr/ri 596032 li/ga/le Gewicht / poids / weight 0,750	Kuhn KUH-15R re/dr/ri KUH-15L li/ga/le  Orig.-Nr. / réf. origine / orig.-part-no. 522600 re/dr/ri 522601 li/ga/le Gewicht / poids / weight 1,100
------------------------------------------------------------------------------------------------------------------------------------------------------------------------------------------------------------------------------------------------------------------------------	------------------------------------------------------------------------------------------------------------------------------------------------------------------------------------------------------------------------------------------------------------------------------------------------------------------------------------------	-------------------------------------------------------------------------------------------------------------------------------------------------------------------------------------------------------------------------------------------------------------------------------	--------------------------------------------------------------------------------------------------------------------------------------------------------------------------------------------------------------------------------------------------------------------------------

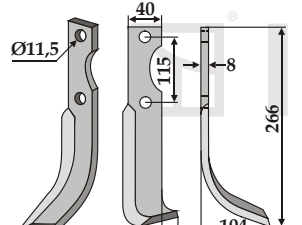
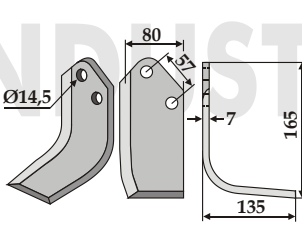
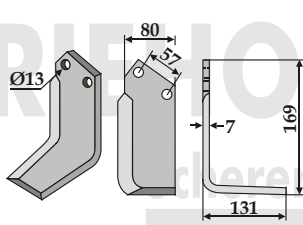
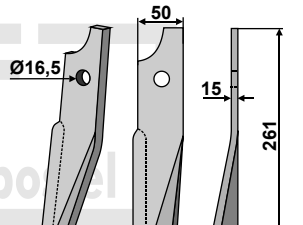
Kuhn KUH-21R re/dr/ri KUH-21L li/ga/le  Orig.-Nr. / réf. origine / orig.-part-no. 520061 re/dr/ri 520062 li/ga/le Gewicht / poids / weight 0,720 Schraube 7/16" UNF x 40 - 12.9 30-71640 boulon / bolt	Kuhn KUH-27R re/dr/ri KUH-27L li/ga/le  Orig.-Nr. / réf. origine / orig.-part-no. 519215 re/dr/ri 519216 li/ga/le Gewicht / poids / weight 1,020 Schraube M14x1,5x35 - 12.9 30-1435 boulon / bolt	Kuhn KUH-29R re/dr/ri KUH-29L li/ga/le  Orig.-Nr. / réf. origine / orig.-part-no. 522275 re/dr/ri 522276 li/ga/le Gewicht / poids / weight 0,940 Schraube 1/2" UNF x 38 - 12.9 30-3903 boulon / bolt	Kuhn KUH-41R re/dr/ri KUH-40L li/ga/le  Orig.-Nr. / réf. origine / orig.-part-no. 523250 re/dr/ri 523251 li/ga/le Gewicht / poids / weight 1,000
-------------------------------------------------------------------------------------------------------------------------------------------------------------------------------------------------------------------------------------------------------------------------------------------------------------------------------------------	--------------------------------------------------------------------------------------------------------------------------------------------------------------------------------------------------------------------------------------------------------------------------------------------------------------------------------------	------------------------------------------------------------------------------------------------------------------------------------------------------------------------------------------------------------------------------------------------------------------------------------------------------------------------------------------	---------------------------------------------------------------------------------------------------------------------------------------------------------------------------------------------------------------------------------------------------------------------------------

 **Original Muzzi-Fräsmesser mit Garantie / couteaux Muzzi avec garantie / Original warranted Muzzi Blades**

- Keine Original-Ersatzteile - Il ne s'agit pas de pièces originales - No genuine spare parts -

Kuhn KUH-42R re/dr/ri KUH-43L li/ga/le	Kuhn KUH-45R re/dr/ri KUH-44L li/ga/le	Kuhn KUH-47R re/dr/ri KUH-46L li/ga/le	Kuhn KUH-49R re/dr/ri KUH-48L li/ga/le
Orig.-Nr. / réf. origine / orig.-part-no. 523248 re/dr/ri 523249 li/ga/le	Orig.-Nr. / réf. origine / orig.-part-no. 523220 re/dr/ri 523219 li/ga/le	Orig.-Nr. / réf. origine / orig.-part-no. 523593 re/dr/ri 523592 li/ga/le	Orig.-Nr. / réf. origine / orig.-part-no. 523590 re/dr/ri 523591 li/ga/le
Gewicht / poids / weight 1,270	Gewicht / poids / weight 1,500	Gewicht / poids / weight 2,000	Gewicht / poids / weight 1,900
Schraube M16x1,5x45 - 12.9 30-1645 boulon / bolt			

Kuhn KUH-54R re/dr/ri KUH-54L li/ga/le	Kuhn KUH-56R re/dr/ri KUH-56L li/ga/le	Kuhn KUH-58R re/dr/ri KUH-59L li/ga/le	Kuhn KUH-60R re/dr/ri KUH-61L li/ga/le
Orig.-Nr. / réf. origine / orig.-part-no. 519338 re/dr/ri 519339 li/ga/le	Orig.-Nr. / réf. origine / orig.-part-no. 522613 re/dr/ri 522612 li/ga/le	Orig.-Nr. / réf. origine / orig.-part-no. 523252 re/dr/ri 523253 li/ga/le	Orig.-Nr. / réf. origine / orig.-part-no. 523596 re/dr/ri 523597 li/ga/le
Gewicht / poids / weight 0,980	Gewicht / poids / weight 1,900	Gewicht / poids / weight 1,180	Gewicht / poids / weight 1,900

Kuhn KUH-64R re/dr/ri KUH-65L li/ga/le	Kuhn KUH-72R re/dr/ri KUH-71L li/ga/le NEU	Kuhn KUH-73R re/dr/ri KUH-74L li/ga/le	Kuhn KUH-75R re/dr/ri KUH-76L li/ga/le
Orig.-Nr. / réf. origine / orig.-part-no. 523599 re/dr/ri 523600 li/ga/le	Orig.-Nr. / réf. origine / orig.-part-no. 515033 re/dr/ri 515032 li/ga/le	Orig.-Nr. / réf. origine / orig.-part-no. K1601090 re/dr/ri K1601100 li/ga/le	Orig.-Nr. / réf. origine / orig.-part-no. K1601450 re/dr/ri K1601460 li/ga/le
Gewicht / poids / weight 1,840	Gewicht / poids / weight 0,720	Gewicht / poids / weight 1,130	Gewicht / poids / weight 1,320
	Schraube M12x1,25x35 - 12.9 30-1235 boulon / bolt	Schraube M16x1,5x45 - 12.9 30-1645 boulon / bolt	

- Keine Original-Ersatzteile - Il ne s'agit pas de pièces originales - No genuine spare parts -

Maße und Gewichte annähernd und unverbindlich - Les mesures et poids sont approximatifs et sous réserve - Dimensions and weights are approximate and not binding - Technische Änderungen vorbehalten - Modifications techniques réservées - Technical changes reserved

Original Muzzi-Fräsmesser mit Garantie / couteaux Muzzi avec garantie / Original warranted Muzzi Blades

Fräsmesser u. Rotorzinken nach Fabrikat:
 Couteaux et lames de rotalabour pour machines:
 Blades and knives for spike rotor to fit:

Technische Änderungen vorbehalten - Modifications techniques réservées - Technical changes reserved
 Maße und Gewichte annähernd und unverbindlich - Les mesures et poids sont approximatifs et sous réserve - Dimensions and weights are approximate and not binding

Kuhn	
KUH-77R re/dr/ri	
KUH-78L li/ga/le	
Orig.-Nr. / réf. origine / orig.-part-no.	
K16103600 re/dr/ri	
K16103700 li/ga/le	
Gewicht / poids / weight	1,700

Kuhn	
KUH-79R re/dr/ri	
KUH-80L li/ga/le	
Orig.-Nr. / réf. origine / orig.-part-no.	
523657000 re/dr/ri	
523658000 li/ga/le	
Gewicht / poids / weight	1,770

Kuhn	
KUH-95R re/dr/ri	
KUH-96L li/ga/le	
Orig.-Nr. / réf. origine / orig.-part-no.	
519370 re/dr/ri	
519371 li/ga/le	
Gewicht / poids / weight	1,040
Schraube M14x1,5x40 - 12.9 boulon / bolt	30-1440

Kuhn	
KUH-98R re/dr/ri	
KUH-97L li/ga/le	
Orig.-Nr. / réf. origine / orig.-part-no.	
K1620010 re/dr/ri	
K1620000 li/ga/le	
Gewicht / poids / weight	0,750
Schraube M12x1,25x35 - 12.9 boulon / bolt	30-1235

Kuhn	
KUH-113R re/dr/ri	
KUH-113L li/ga/le	
Orig.-Nr. / réf. origine / orig.-part-no.	
K1602790 re/dr/ri	
K1602780 li/ga/le	
Gewicht / poids / weight	1,220

Kverneland	
IND-775	
Orig.-Nr. / réf. origine / orig.-part-no.	
MA1305079	
Gewicht / poids / weight	0,610

Landsberg	
LAN-51R re/dr/ri	
LAN-51L li/ga/le	
Orig.-Nr. / réf. origine / orig.-part-no.	
Gewicht / poids / weight	
0,420	

M.A.B. Bocchini	
MAB-01R re/dr/ri	
MAB-01L li/ga/le	
Orig.-Nr. / réf. origine / orig.-part-no.	
9063	
Gewicht / poids / weight	0,350
Schraube M10x1x35 - 10.9 boulon / bolt	30-1035

M.A.B. Bocchini	
MAB-03R re/dr/ri	
MAB-03L li/ga/le	
Orig.-Nr. / réf. origine / orig.-part-no.	
3149	
Gewicht / poids / weight	0,580
Schraube M8x1x30 - 10.9 boulon / bolt	30-830

M.A.B. Bocchini	
MAB-04R re/dr/ri	
MAB-04L li/ga/le	
Orig.-Nr. / réf. origine / orig.-part-no.	
Gewicht / poids / weight	
0,350	
Schraube M8x1x30 - 10.9 boulon / bolt	30-830

Original Muzzi-Fräsmesser mit Garantie / couteaux Muzzi avec garantie / Original warranted Muzzi Blades

- Keine Original-Ersatzteile - Il ne s'agit pas de pièces originales - No genuine spare parts -

M.A.B. Bocchini

MAB-05R re/dr/ri	
MAB-05L li/ga/le	
Orig.-Nr. / réf. origine / orig.-part-no. 5161	
Gewicht / poids / weight	0,430
Schraube M10x1x35 - 10.9 boulon / bolt	30-1035

M.A.B. Bocchini

MAB-07R re/dr/ri	
MAB-07L li/ga/le	
Orig.-Nr. / réf. origine / orig.-part-no. 2523	
Gewicht / poids / weight	0,330
Schraube M10x1x35 - 10.9 boulon / bolt	30-1035

M.A.B. Bocchini

MAB-08R re/dr/ri	
MAB-08L li/ga/le	
Orig.-Nr. / réf. origine / orig.-part-no. 6121	
Gewicht / poids / weight	0,370
Schraube M10x1x35 - 10.9 boulon / bolt	30-1035

M.A.B. Bocchini

MAB-10R re/dr/ri	
MAB-10L li/ga/le	
Orig.-Nr. / réf. origine / orig.-part-no. 4149	
Gewicht / poids / weight	0,470
Schraube M10x1x35 - 10.9 boulon / bolt	30-1035

M.A.B. Bocchini

MAB-15R re/dr/ri	
MAB-15L li/ga/le	
Orig.-Nr. / réf. origine / orig.-part-no. 4189	
Gewicht / poids / weight	0,480
Schraube M10x1x35 - 10.9 boulon / bolt	30-1035

M.A.B. Bocchini

MAB-16R re/dr/ri	
MAB-16L li/ga/le	
Orig.-Nr. / réf. origine / orig.-part-no. 2783	
Gewicht / poids / weight	0,380
Schraube M8x1x30 - 10.9 boulon / bolt	30-830

M.A.B. Bocchini

MAB-17R re/dr/ri	
MAB-17L li/ga/le	
Orig.-Nr. / réf. origine / orig.-part-no. 4152	
Gewicht / poids / weight	0,540
Schraube M10x1x35 - 10.9 boulon / bolt	30-1035

M.A.G.

MAG-03R re/dr/ri	
MAG-03L li/ga/le	
Orig.-Nr. / réf. origine / orig.-part-no.	
Gewicht / poids / weight	0,430

M.Gi.Bi.

MGB-01R re/dr/ri	
MGB-01L li/ga/le	
Orig.-Nr. / réf. origine / orig.-part-no.	
Gewicht / poids / weight	0,450
Schraube M10x1x35 - 10.9 boulon / bolt	30-1035

M.Gi.Bi.

MGB-02R re/dr/ri	
MGB-02L li/ga/le	
Orig.-Nr. / réf. origine / orig.-part-no.	
Gewicht / poids / weight	0,600
Schraube M10x1x35 - 10.9 boulon / bolt	30-1035

- Keine Original-Ersatzteile - Il ne s'agit pas de pièces originales - No genuine spare parts -



Original Muzzi-Fräsmesser mit Garantie / couteaux Muzzi avec garantie / Original warranted Muzzi Blades

Maße und Gewichte annähernd und unverbindlich - Les mesures et poids sont approximatifs et sous réserve - Dimensions and weights are approximate and not binding - Technische Änderungen vorbehalten - Modifications techniques réservées - Technical changes reserved

Fräsmesser u. Rotorzinken nach Fabrikat:
 Couteaux et lames de rotalabour pour machines:
 Blades and knives for spike rotor to fit:

Technische Änderungen vorbehalten - Modifications techniques réservées - Technical changes reserved
 Maße und Gewichte annähernd und unverbindlich - Les mesures et poids sont approximatifs et sous réserve - Dimensions and weights are approximate and not binding

Maletti	
FES-01R re/dr/ri	
FES-01L li/ga/le	
Orig.-Nr. / réf. origine / orig.-part-no.	
Gewicht / poids / weight 1,220	
Schraube M14x1,5x40 - 12.9 boulon / bolt	30-1440

Maletti	
KVE-10R re/dr/ri	
KVE-10L li/ga/le NEU	
Orig.-Nr. / réf. origine / orig.-part-no.	
Gewicht / poids / weight 1,650	
Schraube M14x1,5x40 - 12.9 boulon / bolt	
30-1440	

Maletti	
MAL-01R re/dr/ri	
MAL-01L li/ga/le	
Orig.-Nr. / réf. origine / orig.-part-no.	
0500077 re/dr/ri	
0500078 li/ga/le	
Gewicht / poids / weight 1,170	
Schraube M14x1,5x40 - 12.9 boulon / bolt	30-1440

Maletti	
MAL-03R re/dr/ri	
MAL-03L li/ga/le	
Orig.-Nr. / réf. origine / orig.-part-no.	
0500079 re/dr/ri	
0500080 li/ga/le	
Gewicht / poids / weight 1,290	
Schraube M14x1,5x40 - 12.9 boulon / bolt	30-1440

Maletti	
MAL-04R re/dr/ri	
MAL-04L li/ga/le	
Orig.-Nr. / réf. origine / orig.-part-no.	
0700077 re/dr/ri	
0700078 li/ga/le	
Gewicht / poids / weight 1,280	
Schraube M14x1,5x40 - 12.9 boulon / bolt	30-1440

Maletti	
MAL-05R re/dr/ri	
MAL-05L li/ga/le	
Orig.-Nr. / réf. origine / orig.-part-no.	
0700079 re/dr/ri	
0700080 li/ga/le	
Gewicht / poids / weight 1,700	
Schraube M14x1,5x40 - 12.9 boulon / bolt	30-1440

Maletti	
MAL-06R re/dr/ri	
MAL-06L li/ga/le	
Orig.-Nr. / réf. origine / orig.-part-no.	
0100077 re/dr/ri	
0100078 li/ga/le	
Gewicht / poids / weight 0,970	
Schraube M14x1,5x40 - 12.9 boulon / bolt	30-1440

Maletti	
MAL-07R re/dr/ri	
MAL-07L li/ga/le	
Orig.-Nr. / réf. origine / orig.-part-no.	
0100079 re/dr/ri	
0100080 li/ga/le	
Gewicht / poids / weight 1,030	
Schraube M14x1,5x40 - 12.9 boulon / bolt	30-1440

Maletti	
MAL-08R re/dr/ri	
MAL-08L li/ga/le	
Orig.-Nr. / réf. origine / orig.-part-no.	
1300077 re/dr/ri	
1300078 li/ga/le	
Gewicht / poids / weight 0,710	
Schraube M14x1,5x40 - 12.9 boulon / bolt	30-1440

Maletti	
MAL-09R re/dr/ri	
MAL-09L li/ga/le	
Orig.-Nr. / réf. origine / orig.-part-no.	
1300079 re/dr/ri	
1300080 li/ga/le	
Gewicht / poids / weight 0,810	
Schraube M14x1,5x40 - 12.9 boulon / bolt	30-1440

Maletti	
MAL-10R re/dr/ri	
MAL-10L li/ga/le	
Orig.-Nr. / réf. origine / orig.-part-no.	
1400077 re/dr/ri	
1400078 li/ga/le	
Gewicht / poids / weight 0,650	
Schraube M12x1,25x45 - 12.9 boulon / bolt	
30-1245	

Maletti	
MAL-11R re/dr/ri	
MAL-11L li/ga/le	
Orig.-Nr. / réf. origine / orig.-part-no.	
1400079 re/dr/ri	
1400080 li/ga/le	
Gewicht / poids / weight 0,720	
Schraube M12x1,25x45 - 12.9 boulon / bolt	30-1245

Original Muzzi-Fräsmesser mit Garantie / couteaux Muzzi avec garantie / Original warranted Muzzi Blades

- Keine Original-Ersatzteile - Il ne s'agit pas de pièces originales - No genuine spare parts -

Maletti	
MAL-12R re/dr/ri	
MAL-12L li/ga/le	
Orig.-Nr. / réf. origine / orig.-part-no.	
Gewicht / poids / weight 0,900	
Schraube M14x1,5x40 - 12.9 boulon / bolt	30-1440

Maletti	
MAL-13R re/dr/ri	
MAL-13L li/ga/le	
Orig.-Nr. / réf. origine / orig.-part-no.	
Gewicht / poids / weight 1,000	
Schraube M14x1,5x40 - 12.9 boulon / bolt	30-1440

Maletti	
MAL-16	
Orig.-Nr. / réf. origine / orig.-part-no.	
Gewicht / poids / weight 0,830	
Schraube M14x1,5x40 - 12.9 boulon / bolt	30-1440

Maletti	
MAL-17	
Orig.-Nr. / réf. origine / orig.-part-no.	
Gewicht / poids / weight 0,890	
Schraube M14x1,5x40 - 12.9 boulon / bolt	30-1440

Maletti	
MAL-18	
Orig.-Nr. / réf. origine / orig.-part-no.	
Gewicht / poids / weight 0,980	
Schraube M14x1,5x40 - 12.9 boulon / bolt	30-1440

Maletti	
MAL-19R re/dr/ri	
MAL-19L li/ga/le	
Orig.-Nr. / réf. origine / orig.-part-no.	
FM1302077 re/dr/ri	
FM1302078 li/ga/le	
Gewicht / poids / weight 0,700	
Schraube M14x1,5x40 - 12.9 boulon / bolt	30-1440

Maletti	
MAL-20R re/dr/ri	
MAL-20L li/ga/le	
Orig.-Nr. / réf. origine / orig.-part-no.	
1302179 re/dr/ri	
1302180 li/ga/le	
Gewicht / poids / weight 0,790	
Schraube M14x1,5x40 - 12.9 boulon / bolt	30-1440

Maletti	
IND-775	
Orig.-Nr. / réf. origine / orig.-part-no.	
MA1305079	
Gewicht / poids / weight 0,610	

Maschio	
BRE-14R re/dr/ri	
BRE-14L li/ga/le	
Orig.-Nr. / réf. origine / orig.-part-no.	
40000404 re/dr/ri	
40000405 li/ga/le	
Gewicht / poids / weight 0,570	
Schraube M12x1,25x35 - 12.9 boulon / bolt	30-1235

Maschio	
MAS-01R re/dr/ri	
MAS-01L li/ga/le	
Orig.-Nr. / réf. origine / orig.-part-no.	
19100417 re/dr/ri	
19100418 li/ga/le	
Gewicht / poids / weight 0,610	
Schraube M12x1,25x35 - 12.9 boulon / bolt	30-1235

- Keine Original-Ersatzteile - Il ne s'agit pas de pièces originales - No genuine spare parts -

Maße und Gewichte annähernd und unverbindlich - Les mesures et poids sont approximatifs et sous réserve - Dimensions and weights are approximate and not binding
 Technische Änderungen vorbehalten - Modifications techniques réservées - Technical changes reserved

Original Muzzi-Fräsmesser mit Garantie / couteaux Muzzi avec garantie / Original warranted Muzzi Blades

Fräsmesser u. Rotorzinken nach Fabrikat:
 Couteaux et lames de rotalabour pour machines:
 Blades and knives for spike rotor to fit:

Technische Änderungen vorbehalten - Modifications techniques réservées - Technical changes reserved
 Maße und Gewichte annähernd und unverbindlich - Les mesures et poids sont approximatifs et sous réserve - Dimensions and weights are approximate and not binding

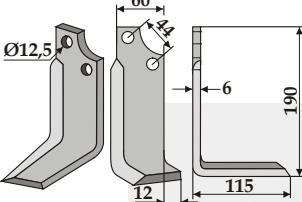
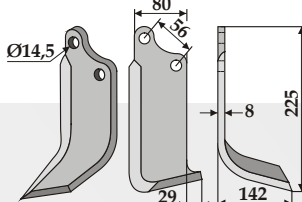
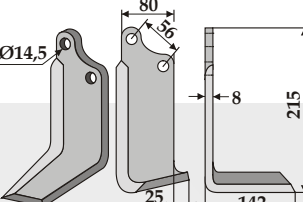
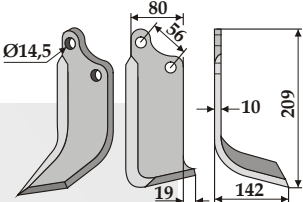
Maschio MAS-02R re/dr/ri MAS-02L li/ga/le 	Maschio MAS-03R re/dr/ri MAS-03L li/ga/le 	Maschio MAS-04R re/dr/ri MAS-04L li/ga/le 	Maschio MAS-05R re/dr/ri MAS-05L li/ga/le 
Orig.-Nr. / réf. origine / orig.-part-no. 19100415 re/dr/ri 19100416 li/ga/le	Orig.-Nr. / réf. origine / orig.-part-no. 01110426 re/dr/ri 01110427 li/ga/le	Orig.-Nr. / réf. origine / orig.-part-no. 01110428 re/dr/ri 01110429 li/ga/le	Orig.-Nr. / réf. origine / orig.-part-no. 13100418 re/dr/ri 13100419 li/ga/le
Gewicht / poids / weight 0,660	Gewicht / poids / weight 1,300	Gewicht / poids / weight 1,350	Gewicht / poids / weight 1,500
Schraube M12x1,25x35 - 12.9 30-1235 boulon / bolt	Schraube M14x1,5x40 - 12.9 30-1440 boulon / bolt	Schraube M14x1,5x40 - 12.9 30-1440 boulon / bolt	

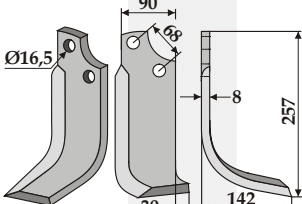
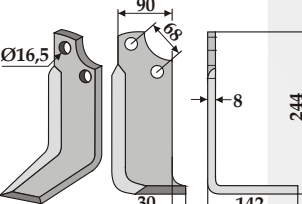
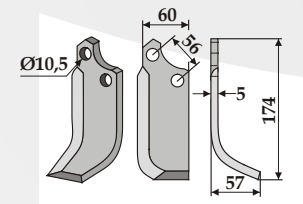
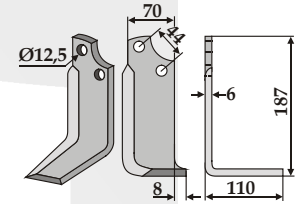
Maschio MAS-06R re/dr/ri MAS-06L li/ga/le 	Maschio MAS-07R re/dr/ri MAS-07L li/ga/le 	Maschio MAS-08R re/dr/ri MAS-08L li/ga/le 	Maschio MAS-09R re/dr/ri MAS-09L li/ga/le 
Orig.-Nr. / réf. origine / orig.-part-no. 20100412 re/dr/ri 20100413 li/ga/le	Orig.-Nr. / réf. origine / orig.-part-no. 20100414 re/dr/ri 20100415 li/ga/le	Orig.-Nr. / réf. origine / orig.-part-no. 21100412 re/dr/ri 21100413 li/ga/le	Orig.-Nr. / réf. origine / orig.-part-no. 19100421 re/dr/ri 19100422 li/ga/le
Gewicht / poids / weight 1,600	Gewicht / poids / weight 1,650	Gewicht / poids / weight 0,360	Gewicht / poids / weight 0,760
Schraube M16x1,5x52 - 12.9 30-1652 boulon / bolt	Schraube M16x1,5x52 - 12.9 30-1652 boulon / bolt	Schraube M10x1x35 - 10.9 30-1035 boulon / bolt	Schraube M12x1,25x35 - 12.9 30-1235 boulon / bolt

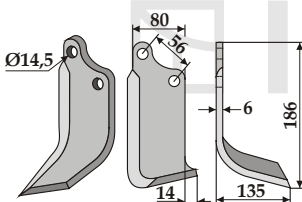
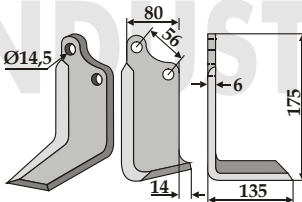
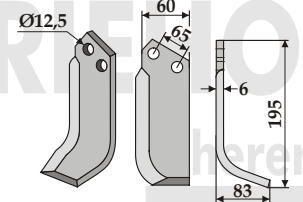
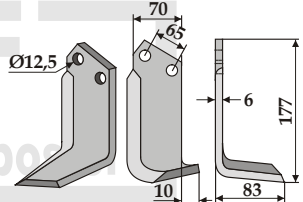
Maschio MAS-10R re/dr/ri MAS-10L li/ga/le 	Maschio MAS-11R re/dr/ri MAS-11L li/ga/le 	Maschio MAS-12R re/dr/ri MAS-12L li/ga/le 	Maschio MAS-13R re/dr/ri MAS-13L li/ga/le 
Orig.-Nr. / réf. origine / orig.-part-no. 02108432 re/dr/ri 02108433 li/ga/le	Orig.-Nr. / réf. origine / orig.-part-no. 02108430 re/dr/ri 02108431 li/ga/le	Orig.-Nr. / réf. origine / orig.-part-no. 00566103 re/dr/ri 00566153 li/ga/le	Orig.-Nr. / réf. origine / orig.-part-no.
Gewicht / poids / weight 0,850	Gewicht / poids / weight 0,850	Gewicht / poids / weight 0,580	Gewicht / poids / weight 0,620
Schraube M14x1,5x35 - 12.9 30-1435 boulon / bolt	Schraube M14x1,5x35 - 12.9 30-1435 boulon / bolt	Schraube M12x1,25x35 - 12.9 30-1235 boulon / bolt	



Original Muzzi-Fräsmesser mit Garantie / couteaux Muzzi avec garantie / Original warranted Muzzi Blades

- Keine Original-Ersatzteile - Il ne s'agit pas de pièces originales - No genuine spare parts -

Maschio	
MAS-14R re/dr/ri	
MAS-14L li/ga/le	
Orig.-Nr. / réf. origine / orig.-part-no.	
24100406 re/dr/ri	
24100407 li/ga/le	
Gewicht / poids / weight	1,650
Schraube M16x1,5x52 - 12.9 boulon / bolt	30-1652

Maschio	
MAS-15R re/dr/ri	
MAS-15L li/ga/le	
Orig.-Nr. / réf. origine / orig.-part-no.	
24100404 re/dr/ri	
24100405 li/ga/le	
Gewicht / poids / weight	1,500
Schraube M16x1,5x52 - 12.9 boulon / bolt	30-1652

Maschio	
MAS-15IR re/dr/ri	
MAS-15IL li/ga/le	
Orig.-Nr. / réf. origine / orig.-part-no.	
09400417 re/dr/ri	
09400418 li/ga/le	
Gewicht / poids / weight	1,800
Schraube M16x1,5x52 - 12.9 boulon / bolt	30-1652

Maschio	
MAS-16	
Orig.-Nr. / réf. origine / orig.-part-no.	
Gewicht / poids / weight	
0,630	

Maschio	
MAS-17R re/dr/ri	
MAS-17L li/ga/le	
Orig.-Nr. / réf. origine / orig.-part-no.	
Gewicht / poids / weight	
0,680	

Maschio	
MAS-18R re/dr/ri	
MAS-18L li/ga/le	
Orig.-Nr. / réf. origine / orig.-part-no.	
19100423 re/dr/ri	
19100424 li/ga/le	
Gewicht / poids / weight	0,740
Schraube M12x1,25x35 - 12.9 boulon / bolt	30-1235

Maschio	
MAS-25R re/dr/ri	
MAS-25L li/ga/le	
Orig.-Nr. / réf. origine / orig.-part-no.	
24100414 re/dr/ri	
24100415 li/ga/le	
Gewicht / poids / weight	0,800

Maschio	
MAS-26R re/dr/ri	
MAS-26L li/ga/le	
Orig.-Nr. / réf. origine / orig.-part-no.	
Gewicht / poids / weight	
1,110	

Maschio	
MAS-27R re/dr/ri	
MAS-27L li/ga/le	
Orig.-Nr. / réf. origine / orig.-part-no.	
24100414 re/dr/ri	
24100415 li/ga/le	
Gewicht / poids / weight	1,800

Maschio	
MAS-28R re/dr/ri	
MAS-28L li/ga/le	
Orig.-Nr. / réf. origine / orig.-part-no.	
Gewicht / poids / weight	
1,680	

Maschio	
MAS-32R re/dr/ri	
MAS-32L li/ga/le	
Orig.-Nr. / réf. origine / orig.-part-no.	
26100417 re/dr/ri	
26100418 li/ga/le	
Gewicht / poids / weight	0,880

Maschio	
MAS-37R re/dr/ri	
MAS-37L li/ga/le	
Orig.-Nr. / réf. origine / orig.-part-no.	
29100405 re/dr/ri	
29100406 li/ga/le	
Gewicht / poids / weight	0,980
Schraube M14x1,5x40 - 12.9 boulon / bolt	30-1440

- Keine Original-Ersatzteile - Il ne s'agit pas de pièces originales - No genuine spare parts -

Maße und Gewichte annähernd und unverbindlich - Les mesures et poids sont approximatifs et sous réserve - Dimensions and weights are approximate and not binding - Technische Änderungen vorbehalten - Modifications techniques réservées - Technical changes reserved



Original Muzzi-Fräsmesser mit Garantie / couteaux Muzzi avec garantie / Original warranted Muzzi Blades

Fräsmesser u. Rotorzinken nach Fabrikat:
 Couteaux et lames de rotalabour pour machines:
 Blades and knives for spike rotor to fit:

Technische Änderungen vorbehalten - Modifications techniques réservées - Technical changes reserved
 Maße und Gewichte annähernd und unverbindlich - Les mesures et poids sont approximatifs et sous réserve - Dimensions and weights are approximate and not binding

Maschio MAS-38R re/dr/ri MAS-38L li/ga/le	Maschio MAS-42R re/dr/ri MAS-42L li/ga/le	Maschio MAS-45R re/dr/ri MAS-45L li/ga/le	Maschio MAS-48R re/dr/ri MAS-48L li/ga/le NEU
Orig.-Nr. / réf. origine / orig.-part-no. 29100407 re/dr/ri 29100408 li/ga/le	Orig.-Nr. / réf. origine / orig.-part-no. 02108432 re/dr/ri 02108433 li/ga/le	Orig.-Nr. / réf. origine / orig.-part-no. 02108430 re/dr/ri 02108431 li/ga/le	Orig.-Nr. / réf. origine / orig.-part-no. 20100412 re/dr/ri 20100413 li/ga/le
Gewicht / poids / weight 1,000	Gewicht / poids / weight 0,950	Gewicht / poids / weight 0,950	Gewicht / poids / weight 1,920
Schraube M14x1,5x40 - 12.9 30-1440 boulon / bolt	Schraube M14x1,5x40 - 12.9 30-1440 boulon / bolt	Schraube M14x1,5x40 - 12.9 30-1440 boulon / bolt	Schraube M16x1,5x52 - 12.9 30-1652 boulon / bolt

Maschio MAS-52R re/dr/ri MAS-52L li/ga/le	Maschio MAS-59R re/dr/ri MAS-59L li/ga/le NEU	Maschio MAS-76R re/dr/ri MAS-76L li/ga/le NEU	Maschio MAS-81R re/dr/ri MAS-81L li/ga/le NEU
Orig.-Nr. / réf. origine / orig.-part-no. 73100404 re/dr/ri 73100405 li/ga/le	Orig.-Nr. / réf. origine / orig.-part-no. 20100414 re/dr/ri 20100415 li/ga/le	Orig.-Nr. / réf. origine / orig.-part-no.	Orig.-Nr. / réf. origine / orig.-part-no. 09400414 re/dr/ri 09400415 li/ga/le
Gewicht / poids / weight 0,600	Gewicht / poids / weight 2,070	Gewicht / poids / weight 1,560	Gewicht / poids / weight 2,070
Schraube M12x1,25x35 - 12.9 30-1235 boulon / bolt			

Massano MSA-03R re/dr/ri MSA-03L li/ga/le	Massano MSA-04R re/dr/ri MSA-04L li/ga/le	Massano MSA-08R re/dr/ri MSA-08L li/ga/le NEU
Orig.-Nr. / réf. origine / orig.-part-no.	Orig.-Nr. / réf. origine / orig.-part-no.	Orig.-Nr. / réf. origine / orig.-part-no.
Gewicht / poids / weight 1,150	Gewicht / poids / weight 1,380	Gewicht / poids / weight 1,650



Original Muzzi-Fräsmesser mit Garantie / couteaux Muzzi avec garantie / Original warranted Muzzi Blades

- Keine Original-Ersatzteile - Il ne s'agit pas de pièces originales - No genuine spare parts -

Fräsmesser u. Rotorzinken nach Fabrikat:
 Couteaux et lames de rotalabour pour machines:
 Blades and knives for spike rotor to fit:

Massano

MSA-10R re/dr/ri
MSA-10L li/ga/le **NEU**

Orig.-Nr. / réf. origine / orig.-part-no.

Gewicht / poids / weight 0,640

Massano

MSA-12R re/dr/ri
MSA-12L li/ga/le **NEU**

Orig.-Nr. / réf. origine / orig.-part-no.

Gewicht / poids / weight 1,200

Massano

MSA-17R re/dr/ri
MSA-17L li/ga/le **NEU**

Orig.-Nr. / réf. origine / orig.-part-no.

Gewicht / poids / weight 0,650

M.E.A.A.T.

BRE-13R re/dr/ri
BRE-13L li/ga/le

Orig.-Nr. / réf. origine / orig.-part-no.

Gewicht / poids / weight 0,340

Schraube M10x1x30 - 10.9 30-1030
 boulon / bolt

M.E.A.A.T.

COM-07R re/dr/ri
COM-07L li/ga/le

Orig.-Nr. / réf. origine / orig.-part-no.

Gewicht / poids / weight 0,440

M.E.A.A.T.

MEA-01R re/dr/ri
MEA-01L li/ga/le

Orig.-Nr. / réf. origine / orig.-part-no.

Gewicht / poids / weight 0,280

Schraube M8x1x30 - 10.9 30-830
 boulon / bolt

M.E.A.A.T.

MEA-04R re/dr/ri
MEA-04L li/ga/le **NEU**

Orig.-Nr. / réf. origine / orig.-part-no.

Gewicht / poids / weight 0,450

M.E.A.A.T.

PAS-05R re/dr/ri
PAS-05L li/ga/le

Orig.-Nr. / réf. origine / orig.-part-no.

Gewicht / poids / weight 0,490

Schraube M12x1,2x35 - 12.9 30-1235
 boulon / bolt

Mearelli

BRE-13R re/dr/ri
BRE-13L li/ga/le

Orig.-Nr. / réf. origine / orig.-part-no.

Gewicht / poids / weight 0,340

Mearelli

MEA-01R re/dr/ri
MEA-01L li/ga/le

Orig.-Nr. / réf. origine / orig.-part-no.

Gewicht / poids / weight 0,280

Mearelli

PAS-05R re/dr/ri
PAS-05L li/ga/le

Orig.-Nr. / réf. origine / orig.-part-no.

Gewicht / poids / weight 0,490

- Keine Original-Ersatzteile - Il ne s'agit pas de pièces originales - No genuine spare parts -

Maße und Gewichte annähernd und unverbindlich - Les mesures et poids sont approximatifs et sous réserve - Dimensions and weights are approximate and not binding - Technische Änderungen vorbehalten - Modifications techniques réservées - Technical changes reserved



Original Muzzi-Fräsmesser mit Garantie / couteaux Muzzi avec garantie / Original warranted Muzzi Blades

Fräsmesser u. Rotorzinken nach Fabrikat:
 Couteaux et lames de rotalabour pour machines:
 Blades and knives for spike rotor to fit:

Technische Änderungen vorbehalten - Modifications techniques réservées - Technical changes reserved
 Maße und Gewichte annähernd und unverbindlich - Les mesures et poids sont approximatifs et sous réserve - Dimensions and weights are approximate and not binding

Meritano	
MER-01R re/dr/ri	
MER-01L li/ga/le	
Orig.-Nr. / réf. origine / orig.-part-no.	
Gewicht / poids / weight 0,800	
Schraube M14x1,5x40 - 12.9 boulon / bolt	30-1440

Meritano	
MER-02R re/dr/ri	
MER-02L li/ga/le	
Orig.-Nr. / réf. origine / orig.-part-no.	
Gewicht / poids / weight 0,990	
Schraube M14x1,5x40 - 12.9 boulon / bolt	30-1440

Meritano	
MER-03R re/dr/ri	
MER-03L li/ga/le	
Orig.-Nr. / réf. origine / orig.-part-no.	
Gewicht / poids / weight 1,150	
Schraube M14x1,5x40 - 12.9 boulon / bolt	30-1440

Meritano	
MER-05R re/dr/ri	
MER-05L li/ga/le	
Orig.-Nr. / réf. origine / orig.-part-no.	
Gewicht / poids / weight 0,900	
Schraube M14x1,5x40 - 12.9 boulon / bolt	30-1440

Meritano	
MER-09R re/dr/ri NEU	
MER-09L li/ga/le NEU	
Orig.-Nr. / réf. origine / orig.-part-no.	
Gewicht / poids / weight 1,000	
Schraube M14x1,5x40 - 12.9 boulon / bolt	30-1440

Meritano	
MER-11R re/dr/ri NEU	
MER-11L li/ga/le NEU	
Orig.-Nr. / réf. origine / orig.-part-no.	
Gewicht / poids / weight 1,000	
Schraube M14x1,5x40 - 12.9 boulon / bolt	30-1440

Muratori	
MUR-03R re/dr/ri	
MUR-03L li/ga/le	
Orig.-Nr. / réf. origine / orig.-part-no.	
120058 re/dr/ri	
120059 li/ga/le	
Gewicht / poids / weight 1,250	
Schraube M14x1,5x40 - 12.9 boulon / bolt	30-1440

Muratori	
MUR-04R re/dr/ri	
MUR-04L li/ga/le	
Orig.-Nr. / réf. origine / orig.-part-no.	
120060 re/dr/ri	
120061 li/ga/le	
Gewicht / poids / weight 1,170	
Schraube M14x1,5x40 - 12.9 boulon / bolt	30-1440

Muratori	
MUR-05R re/dr/ri	
MUR-05L li/ga/le	
Orig.-Nr. / réf. origine / orig.-part-no.	
12000700 re/dr/ri	
12000800 li/ga/le	
Gewicht / poids / weight 0,760	
Schraube M12x1,25x35 - 12.9 boulon / bolt	30-1235

Muratori	
MUR-06R re/dr/ri	
MUR-06L li/ga/le	
Orig.-Nr. / réf. origine / orig.-part-no.	
12000301 re/dr/ri	
12000401 li/ga/le	
Gewicht / poids / weight 0,650	
Schraube M12x1,25x35 - 12.9 boulon / bolt	30-1235

Original Muzzi-Fräsmesser mit Garantie / couteaux Muzzi avec garantie / Original warranted Muzzi Blades

- Keine Original-Ersatzteile - Il ne s'agit pas de pièces originales - No genuine spare parts -

Muratori MUR-07R re/dr/ri MUR-07L li/ga/le	Muratori MUR-08R re/dr/ri MUR-08L li/ga/le	Muratori MUR-09R re/dr/ri MUR-09L li/ga/le	Muratori MUR-10R re/dr/ri MUR-10L li/ga/le
Orig.-Nr. / réf. origine / orig.-part-no. 12000101 re/dr/ri 12000201 li/ga/le	Orig.-Nr. / réf. origine / orig.-part-no.	Orig.-Nr. / réf. origine / orig.-part-no. 12014200 re/dr/ri 12014300 li/ga/le	Orig.-Nr. / réf. origine / orig.-part-no.
Gewicht / poids / weight 0,650	Gewicht / poids / weight 0,830	Gewicht / poids / weight 0,390	Gewicht / poids / weight 0,730
Schraube M12x1,25x35 - 12.9 30-1235 boulon / bolt	Schraube M12x1,25x35 - 12.9 30-1235 boulon / bolt	Schraube M10x1x30 - 10.9 30-1235 boulon / bolt	

Muratori MUR-11	Muratori MUR-12R re/dr/ri MUR-12L li/ga/le	Muratori MUR-13R re/dr/ri MUR-13L li/ga/le NEU	Muratori MUR-14R re/dr/ri MUR-14L li/ga/le
Orig.-Nr. / réf. origine / orig.-part-no. 12008701	Orig.-Nr. / réf. origine / orig.-part-no. 12002200 re/dr/ri 12002300 li/ga/le	Orig.-Nr. / réf. origine / orig.-part-no. 12017300 re/dr/ri 12017400 li/ga/le	Orig.-Nr. / réf. origine / orig.-part-no. 120127 re/dr/ri 120128 li/ga/le
Gewicht / poids / weight 1,000	Gewicht / poids / weight 0,900	Gewicht / poids / weight 1,480	Gewicht / poids / weight 1,050
	Schraube M12x1,25x35 - 12.9 30-1235 boulon / bolt		Schraube M14x1,5x40 - 12.9 30-1440 boulon / bolt

Muratori MUR-15R re/dr/ri MUR-15L li/ga/le	Muratori MUR-17R re/dr/ri MUR-17L li/ga/le NEU	Muratori MUR-19R re/dr/ri MUR-19L li/ga/le	Muratori MUR-24R re/dr/ri MUR-24L li/ga/le NEU
Orig.-Nr. / réf. origine / orig.-part-no. 12012502 re/dr/ri 12012602 li/ga/le	Orig.-Nr. / réf. origine / orig.-part-no. 12013701 re/dr/ri 12013801 li/ga/le	Orig.-Nr. / réf. origine / orig.-part-no. 12002801 re/dr/ri 12002901 li/ga/le	Orig.-Nr. / réf. origine / orig.-part-no. 12019601 re/dr/ri 12019501 li/ga/le
Gewicht / poids / weight 1,020	Gewicht / poids / weight 0,820	Gewicht / poids / weight 0,850	Gewicht / poids / weight 1,480
Schraube M14x1,5x40 - 12.9 30-1440 boulon / bolt	Schraube M14x1,5x40 - 12.9 30-1440 boulon / bolt	Schraube M12x1,25x35 - 12.9 30-1235 boulon / bolt	Schraube M16x1,5x52 - 12.9 30-1652 boulon / bolt

- Keine Original-Ersatzteile - Il ne s'agit pas de pièces originales - No genuine spare parts -

Maße und Gewichte annähernd und unverbindlich - Les mesures et poids sont approximatifs et sous réserve - Dimensions and weights are approximate and not binding - Technische Änderungen vorbehalten - Modifications techniques réservées - Technical changes reserved



Original Muzzi-Fräsmesser mit Garantie / couteaux Muzzi avec garantie / Original warranted Muzzi Blades

Fräsmesser u. Rotorzinken nach Fabrikat:
 Couteaux et lames de rotalabour pour machines:
 Blades and knives for spike rotor to fit:

Technische Änderungen vorbehalten - Modifications techniques réservées - Technical changes reserved
 Maße und Gewichte annähernd und unverbindlich - Les mesures et poids sont approximatifs et sous réserve - Dimensions and weights are approximate and not binding

Muratori SOV-02R re/dr/ri SOV-02L li/ga/le		Muratori SOV-03R re/dr/ri SOV-03L li/ga/le		Muratori SOV-04R re/dr/ri SOV-04L li/ga/le		Muratori SOV-06R re/dr/ri SOV-06L li/ga/le	
Orig.-Nr. / réf. origine / orig.-part-no. 12000500 re/dr/ri 12000600 li/ga/le		Orig.-Nr. / réf. origine / orig.-part-no.		Orig.-Nr. / réf. origine / orig.-part-no.		Orig.-Nr. / réf. origine / orig.-part-no.	
Gewicht / poids / weight 0,800		Gewicht / poids / weight 0,800		Gewicht / poids / weight 1,050		Gewicht / poids / weight 0,800	
Schraube M12x1,25x35 - 12.9 30-1235 boulon / bolt		Schraube M14x1,5x40 - 12.9 30-1440 boulon / bolt		Schraube M14x1,5x40 - 12.9 30-1440 boulon / bolt		Schraube M14x1,5x40 - 12.9 30-1440 boulon / bolt	

Nardi NAR-01R re/dr/ri NAR-01L li/ga/le		Nardi NAR-03R re/dr/ri NAR-03L li/ga/le		Nardi NAR-04R re/dr/ri NAR-04L li/ga/le		Nardi NAR-05R re/dr/ri NAR-05L li/ga/le	
Orig.-Nr. / réf. origine / orig.-part-no. 4C5012 re/dr/ri 4CS5012 li/ga/le		Orig.-Nr. / réf. origine / orig.-part-no. 5C5009 re/dr/ri 5CS5009 li/ga/le		Orig.-Nr. / réf. origine / orig.-part-no. 5C5012 re/dr/ri 5CS5012 li/ga/le		Orig.-Nr. / réf. origine / orig.-part-no. 5C5015 re/dr/ri 5CS5015 li/ga/le	
Gewicht / poids / weight 0,730		Gewicht / poids / weight 0,620		Gewicht / poids / weight 0,810		Gewicht / poids / weight 0,420	
Schraube M12x1,25x35 - 12.9 30-1235 boulon / bolt		Schraube M12x1,25x35 - 12.9 30-1235 boulon / bolt		Schraube M12x1,25x35 - 12.9 30-1235 boulon / bolt		Schraube M10x1x30 - 10.9 30-1030 boulon / bolt	

Nardi NAR-07R re/dr/ri NAR-07L li/ga/le		Nardi NAR-09R re/dr/ri NAR-09L li/ga/le		Nardi NAR-13R re/dr/ri NAR-13L li/ga/le		Nardi NAR-15R re/dr/ri NAR-15L li/ga/le	
Orig.-Nr. / réf. origine / orig.-part-no. 5½C5002 re/dr/ri 5½CS5002 li/ga/le		Orig.-Nr. / réf. origine / orig.-part-no. 6½C5002 re/dr/ri 6½CS5002 li/ga/le		Orig.-Nr. / réf. origine / orig.-part-no. 6C5009 re/dr/ri 6CS5009 li/ga/le		Orig.-Nr. / réf. origine / orig.-part-no. 8C5003 re/dr/ri 8CS5003 li/ga/le	
Gewicht / poids / weight 1,050		Gewicht / poids / weight 1,090		Gewicht / poids / weight 0,810		Gewicht / poids / weight 1,150	
Schraube M12x1,25x35 - 12.9 30-1235 boulon / bolt		Schraube M14x1,5x40 - 12.9 30-1440 boulon / bolt		Schraube M12x1,25x35 - 12.9 30-1235 boulon / bolt		Schraube M14x1,5x40 - 12.9 30-1440 boulon / bolt	

Original Muzzi-Fräsmesser mit Garantie / couteaux Muzzi avec garantie / Original warranted Muzzi Blades

- Keine Original-Ersatzteile - Il ne s'agit pas de pièces originales - No genuine spare parts -

Nardi	
NAR-16R re/dr/ri	
NAR-16L li/ga/le	
Orig.-Nr. / réf. origine / orig.-part-no.	
8C5013 re/dr/ri	
8CS5013 li/ga/le	
Gewicht / poids / weight	1,000
Schraube M14x1,5x40 - 12.9 boulon / bolt	30-1440

Nardi	
NAR-17R re/dr/ri	
NAR-17L li/ga/le	
Orig.-Nr. / réf. origine / orig.-part-no.	
5C5013 re/dr/ri	
5CS5013 li/ga/le	
Gewicht / poids / weight	0,880
Schraube M12x1,25x35 - 12.9 boulon / bolt	30-1235

Nibbi Bruno	
EUR-01R re/dr/ri	
EUR-01L li/ga/le	
Orig.-Nr. / réf. origine / orig.-part-no.	
Gewicht / poids / weight	
0,160	
Schraube M8x1x30 - 10.9 boulon / bolt	30-830

Nibbi Bruno	
NIB-01R re/dr/ri	
NIB-01L li/ga/le	
Orig.-Nr. / réf. origine / orig.-part-no.	
Gewicht / poids / weight	
0,300	
Schraube M8x1x30 - 10.9 boulon / bolt	30-830

Nibbi Bruno	
NIB-02R re/dr/ri	
NIB-02L li/ga/le	
Orig.-Nr. / réf. origine / orig.-part-no.	
Gewicht / poids / weight	
0,520	
Schraube M10x1x35 - 10.9 boulon / bolt	30-1035

Nibbi Bruno	
NIB-03R re/dr/ri	
NIB-03L li/ga/le	
Orig.-Nr. / réf. origine / orig.-part-no.	
Gewicht / poids / weight	
0,350	
Schraube M8x1x30 - 10.9 boulon / bolt	30-830

Nibbi Bruno	
NIB-04R re/dr/ri	
NIB-04L li/ga/le	
Orig.-Nr. / réf. origine / orig.-part-no.	
Gewicht / poids / weight	
0,540	
Schraube M12x1,25x35 - 12.9 boulon / bolt	30-1235

Nibbi Bruno	
NIB-06R re/dr/ri	
NIB-06L li/ga/le	
Orig.-Nr. / réf. origine / orig.-part-no.	
Gewicht / poids / weight	
0,600	
Schraube M12x1,25x35 - 12.9 boulon / bolt	30-1235

Nibbi Bruno	
NIB-07R re/dr/ri	
NIB-07L li/ga/le	
Orig.-Nr. / réf. origine / orig.-part-no.	
K4303230 re/dr/ri	
K4303240 li/ga/le	
Gewicht / poids / weight	0,350
Schraube M10x1x30 - 10.9 boulon / bolt	30-1030

Nibbi Bruno	
NIB-08R re/dr/ri	
NIB-08L li/ga/le	
Orig.-Nr. / réf. origine / orig.-part-no.	
Gewicht / poids / weight	
0,230	
Schraube M8x1x30 - 10.9 boulon / bolt	30-830

Nibbi Bruno	
NIB-10R re/dr/ri	
NIB-10L li/ga/le	
Orig.-Nr. / réf. origine / orig.-part-no.	
Gewicht / poids / weight	
0,650	

Nibbi Bruno	
NIB-11R re/dr/ri	
NIB-11L li/ga/le	
Orig.-Nr. / réf. origine / orig.-part-no.	
Gewicht / poids / weight	
0,650	

- Keine Original-Ersatzteile - Il ne s'agit pas de pièces originales - No genuine spare parts -

Maße und Gewichte annähernd und unverbindlich - Les mesures et poids sont approximatifs et sous réserve - Dimensions and weights are approximate and not binding - Technische Änderungen vorbehalten - Modifications techniques réservées - Technical changes reserved



Original Muzzi-Fräsmesser mit Garantie / couteaux Muzzi avec garantie / Original warranted Muzzi Blades

Fräsmesser u. Rotorzinken nach Fabrikat:
 Couteaux et lames de rotalabour pour machines:
 Blades and knives for spike rotor to fit:

Technische Änderungen vorbehalten - Modifications techniques réservées - Technical changes reserved
 Maße und Gewichte annähernd und unverbindlich - Les mesures et poids sont approximatifs et sous réserve - Dimensions and weights are approximate and not binding

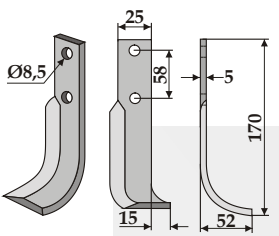
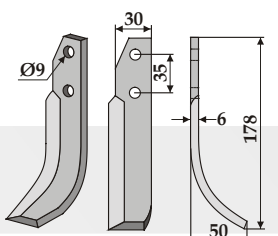
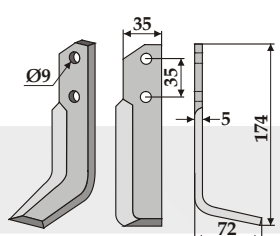
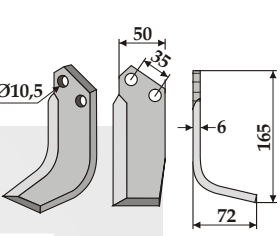
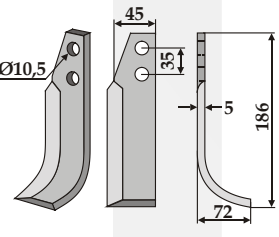
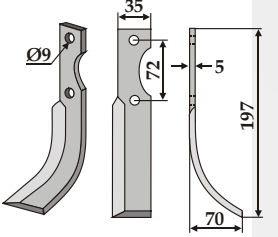
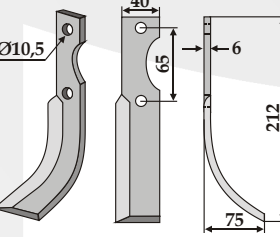
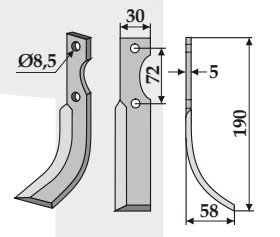
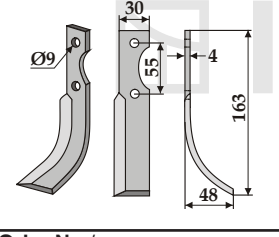
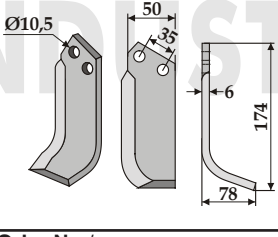
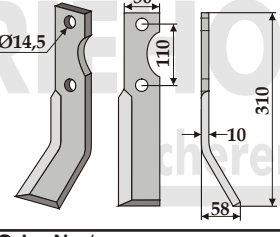
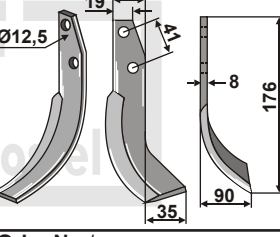
Nibbi Bruno NIB-15R re/dr/ri NIB-15L li/ga/le 		Nibbi Decimo NID-02R re/dr/ri NID-02L li/ga/le 		Nibbi Decimo NID-03R re/dr/ri NID-03L li/ga/le 		Nibbi Decimo NID-04R re/dr/ri NID-04L li/ga/le 	
Orig.-Nr. / réf. origine / orig.-part-no. K3501790 re/dr/ri K3501780 li/ga/le		Orig.-Nr. / réf. origine / orig.-part-no.		Orig.-Nr. / réf. origine / orig.-part-no.		Orig.-Nr. / réf. origine / orig.-part-no.	
Gewicht / poids / weight 0,180		Gewicht / poids / weight 0,250		Gewicht / poids / weight 0,340		Gewicht / poids / weight 0,400	
Schraube M8x1x30 - 10.9 30-830 boulon / bolt		Schraube M8x1x30 - 10.9 30-830 boulon / bolt		Schraube M8x1x30 - 10.9 30-830 boulon / bolt		Schraube M10x1x30 - 10.9 30-1030 boulon / bolt	
Nibbi Decimo NID-05R re/dr/ri NID-05L li/ga/le 		Nibbi Decimo NID-11R re/dr/ri NID-11L li/ga/le 		Nibbi Decimo NID-13R re/dr/ri NID-13L li/ga/le 		Nibbi Decimo NID-15R re/dr/ri NID-15L li/ga/le 	
Orig.-Nr. / réf. origine / orig.-part-no.		Orig.-Nr. / réf. origine / orig.-part-no.		Orig.-Nr. / réf. origine / orig.-part-no.		Orig.-Nr. / réf. origine / orig.-part-no.	
Gewicht / poids / weight 0,350		Gewicht / poids / weight 0,300		Gewicht / poids / weight 0,410		Gewicht / poids / weight 0,230	
Schraube M10x1x30 - 10.9 30-1030 boulon / bolt		Schraube M8x1x30 - 10.9 30-830 boulon / bolt		Schraube M10x1x35 - 10.9 30-1035 boulon / bolt		Schraube M8x1x30 - 10.9 30-830 boulon / bolt	
Nibbi Decimo NID-16R re/dr/ri NID-16L li/ga/le 		Nibbi Decimo VAL-08R re/dr/ri VAL-08L li/ga/le 		Niemeyer NIM-01R re/dr/ri NIM-01L li/ga/le 		Ommas OMM-01R re/dr/ri OMM-01L li/ga/le 	
Orig.-Nr. / réf. origine / orig.-part-no.		Orig.-Nr. / réf. origine / orig.-part-no.		Orig.-Nr. / réf. origine / orig.-part-no.		Orig.-Nr. / réf. origine / orig.-part-no.	
Gewicht / poids / weight 0,180		Gewicht / poids / weight 0,410		Gewicht / poids / weight 1,120		Gewicht / poids / weight 0,500	
Schraube M8x1x30 - 10.9 30-830 boulon / bolt		Schraube M10x1x30 - 10.9 30-1030 boulon / bolt		Schraube M8x1x30 - 10.9 30-830 boulon / bolt		Schraube M12x1,25x35 - 12.9 30-1235 boulon / bolt	



Original Muzzi-Fräsmesser mit Garantie / couteaux Muzzi avec garantie / Original warranted Muzzi Blades

- Keine Original-Ersatzteile - Il ne s'agit pas de pièces originales - No genuine spare parts -

Ommas	
SOV-03R re/dr/ri	
SOV-03L li/ga/le	
Orig.-Nr. / réf. origine / orig.-part-no.	
140	
Gewicht / poids / weight	0,800
Schraube M14x1,5x40 - 12.9 boulon / bolt	30-1440

Ompi	
OMP-03R re/dr/ri	
OMP-03L li/ga/le	
Orig.-Nr. / réf. origine / orig.-part-no.	
Gewicht / poids / weight	0,340
Schraube M10x1x30 - 10.9 boulon / bolt	30-1030

Oosterlaan	
BER-23R re/dr/ri	
BER-23L li/ga/le NEU	
Orig.-Nr. / réf. origine / orig.-part-no.	
Gewicht / poids / weight	0,440

Oosterlaan	
BER-24R re/dr/ri	
BER-24L li/ga/le NEU	
Orig.-Nr. / réf. origine / orig.-part-no.	
Gewicht / poids / weight	0,280

Ortolan	
ORT-01R re/dr/ri	
ORT-01L li/ga/le	
Orig.-Nr. / réf. origine / orig.-part-no.	
Gewicht / poids / weight	0,520
Schraube M12x1,25x35 - 12.9 boulon / bolt	30-1235

Ortolan	
ORT-02R re/dr/ri	
ORT-02L li/ga/le	
Orig.-Nr. / réf. origine / orig.-part-no.	
Gewicht / poids / weight	0,480
Schraube M12x1,25x35 - 12.9 boulon / bolt	30-1235

Ortolan	
ORT-04R re/dr/ri	
ORT-04L li/ga/le	
Orig.-Nr. / réf. origine / orig.-part-no.	
Gewicht / poids / weight	0,880
Schraube M14x1,5x40 - 12.9 boulon / bolt	30-1440

P.G.S.	
PGS-09R re/dr/ri	
PGS-09L li/ga/le	
Orig.-Nr. / réf. origine / orig.-part-no.	
Gewicht / poids / weight	0,630
Schraube M12x1,25x35 - 12.9 boulon / bolt	30-1235

Palladino	
CEL-10R re/dr/ri	
CEL-10L li/ga/le	
Orig.-Nr. / réf. origine / orig.-part-no.	
Gewicht / poids / weight	1,230
Schraube M14x1,5x40 - 12.9 boulon / bolt	30-1440

Palladino	
PAL-01R re/dr/ri	
PAL-01L li/ga/le	
Orig.-Nr. / réf. origine / orig.-part-no.	
Gewicht / poids / weight	0,710
Schraube M12x1,25x35 - 12.9 boulon / bolt	30-1235

Palladino	
SAN-01R re/dr/ri	
SAN-01L li/ga/le	
Orig.-Nr. / réf. origine / orig.-part-no.	
Gewicht / poids / weight	0,940
Schraube M14x1,5x40 - 12.9 boulon / bolt	30-1440

- Keine Original-Ersatzteile - Il ne s'agit pas de pièces originales - No genuine spare parts -

Maße und Gewichte annähernd und unverbindlich - Les mesures et poids sont approximatifs et sous réserve - Dimensions and weights are approximate and not binding - Technische Änderungen vorbehalten - Modifications techniques réservées - Technical changes reserved



Original Muzzi-Fräsmesser mit Garantie / couteaux Muzzi avec garantie / Original warranted Muzzi Blades

Fräsmesser u. Rotorzinken nach Fabrikat:
 Couteaux et lames de rotalabour pour machines:
 Blades and knives for spike rotor to fit:

Technische Änderungen vorbehalten - Modifications techniques réservées - Technical changes reserved
 Maße und Gewichte annähernd und unverbindlich - Les mesures et poids sont approximatifs et sous réserve - Dimensions and weights are approximate and not binding

Pasbo PAB-01R re/dr/ri PAB-01L li/ga/le		Pasbo PAB-02R re/dr/ri PAB-02L li/ga/le		Pasbo PAB-03R re/dr/ri PAB-03L li/ga/le		Pasbo PAB-04R re/dr/ri PAB-04L li/ga/le	
Orig.-Nr. / réf. origine / orig.-part-no.		Orig.-Nr. / réf. origine / orig.-part-no.		Orig.-Nr. / réf. origine / orig.-part-no.		Orig.-Nr. / réf. origine / orig.-part-no.	
G2-G51-G62HP5		G11-14-72-83-84		G11-14-72-83-84		G14-G84	
Gewicht / poids / weight		Gewicht / poids / weight		Gewicht / poids / weight		Gewicht / poids / weight	
0,350		0,440		0,460		0,550	
Schraube M8x1x30 - 10.9 boulon / bolt		Schraube M10x1x35 - 10.9 boulon / bolt		Schraube M10x1x35 - 10.9 boulon / bolt		Schraube M10x1x35 - 10.9 boulon / bolt	
30-830		30-1035		30-1035		30-1035	
Pasquali BCS-13R re/dr/ri BCS-13L li/ga/le		Pasquali GRI-06R re/dr/ri GRI-06L li/ga/le		Pasquali PAS-02R re/dr/ri PAS-02L li/ga/le		Pasquali PAS-04R re/dr/ri PAS-04L li/ga/le	
Orig.-Nr. / réf. origine / orig.-part-no.		Orig.-Nr. / réf. origine / orig.-part-no.		Orig.-Nr. / réf. origine / orig.-part-no.		Orig.-Nr. / réf. origine / orig.-part-no.	
XB40-SB30-SB20		478		AX20/21(599)		N.F.592/598	
Gewicht / poids / weight		Gewicht / poids / weight		Gewicht / poids / weight		Gewicht / poids / weight	
0,270		0,370		0,520		0,500	
Schraube M8x1x30 - 10.9 boulon / bolt		Schraube M10x1x30 - 10.9 boulon / bolt		Schraube M10x1x35 - 10.9 boulon / bolt		Schraube M12x1,25x35 - 12.9 boulon / bolt	
30-830		30-1030		30-1035		30-1235	
Pasquali PAS-05R re/dr/ri PAS-05L li/ga/le		Pasquali PAS-09R re/dr/ri PAS-09L li/ga/le		Pasquali PAS-11R re/dr/ri PAS-11L li/ga/le			
Orig.-Nr. / réf. origine / orig.-part-no.		Orig.-Nr. / réf. origine / orig.-part-no.		Orig.-Nr. / réf. origine / orig.-part-no.			
N.F.592/598		591-F901(HP6)		588-F912/923			
Gewicht / poids / weight		Gewicht / poids / weight		Gewicht / poids / weight			
0,490		0,310		0,350			
Schraube M12x1,25x35 - 12.9 boulon / bolt		Schraube M10x1x30 - 10.9 boulon / bolt		Schraube M10x1x30 - 10.9 boulon / bolt			
30-1235		30-1030		30-1030			



Original Muzzi-Fräsmesser mit Garantie / couteaux Muzzi avec garantie / Original warranted Muzzi Blades

- Keine Original-Ersatzteile - Il ne s'agit pas de pièces originales - No genuine spare parts -

Pasquali	
PAS-12R re/dr/ri	
PAS-12L li/ga/le	
Orig.-Nr. / réf. origine / orig.-part-no.	
532	
Gewicht / poids / weight	0,190
Schraube M8x1x30 - 10.9 boulon / bolt	30-830

Pasquali	
PAS-13R re/dr/ri	
PAS-13L li/ga/le	
Orig.-Nr. / réf. origine / orig.-part-no.	
NF557	
Gewicht / poids / weight	0,450
Schraube M12x1,25x35 - 12.9 boulon / bolt	30-1235

Pasquali	
PAS-14R re/dr/ri	
PAS-14L li/ga/le	
Orig.-Nr. / réf. origine / orig.-part-no.	
Gewicht / poids / weight	0,550
Schraube M12x1,25x35 - 12.9 boulon / bolt	30-1235

Pasquali	
PAS-15R re/dr/ri	
PAS-15L li/ga/le	
Orig.-Nr. / réf. origine / orig.-part-no.	
478	
Gewicht / poids / weight	0,420
Schraube M10x1x35 - 10.9 boulon / bolt	30-1035

Pasquali	
PAS-16R re/dr/ri	
PAS-16L li/ga/le	
Orig.-Nr. / réf. origine / orig.-part-no.	
532	
Gewicht / poids / weight	0,290
Schraube M10x1x35 - 10.9 boulon / bolt	30-1035

Pegoraro	
PEG-01R re/dr/ri	
PEG-01L li/ga/le	
Orig.-Nr. / réf. origine / orig.-part-no.	
1852 re/dr/ri	
1853 li/ga/le	
Gewicht / poids / weight	0,820
Schraube M12x1,25x35 - 12.9 boulon / bolt	30-1235

Pegoraro	
PEG-02R re/dr/ri	
PEG-02L li/ga/le	
Orig.-Nr. / réf. origine / orig.-part-no.	
0833 re/dr/ri	
0834 li/ga/le	
Gewicht / poids / weight	1,350
Schraube M12x1,25x35 - 12.9 boulon / bolt	30-1235

Pegoraro	
PEG-03R re/dr/ri	
PEG-03L li/ga/le	
Orig.-Nr. / réf. origine / orig.-part-no.	
4585 re/dr/ri	
4586 li/ga/le	
Gewicht / poids / weight	1,200
Schraube M14x1,5x40 - 12.9 boulon / bolt	30-1440

Pegoraro	
PEG-04	
Orig.-Nr. / réf. origine / orig.-part-no.	
5329	
Gewicht / poids / weight	0,670
Schraube M12x1,25x35 - 12.9 boulon / bolt	30-1235

Pegoraro	
PEG-05	
Orig.-Nr. / réf. origine / orig.-part-no.	
5333	
Gewicht / poids / weight	0,930
Schraube M14x1,5x40 - 12.9 boulon / bolt	30-1440

Pegoraro	
PEG-06	
Orig.-Nr. / réf. origine / orig.-part-no.	
6955	
Gewicht / poids / weight	0,810
Schraube M16x1,5x60 - 12.9 boulon / bolt	30-1660

- Keine Original-Ersatzteile - Il ne s'agit pas de pièces originales - No genuine spare parts -

Maße und Gewichte annähernd und unverbindlich - Les mesures et poids sont approximatifs et sous réserve - Dimensions and weights are approximate and not binding - Technische Änderungen vorbehalten - Modifications techniques réservées - Technical changes reserved



Original Muzzi-Fräsmesser mit Garantie / couteaux Muzzi avec garantie / Original warranted Muzzi Blades

Technische Änderungen vorbehalten - Modifications techniques réservées - Technical changes reserved
 Maße und Gewichte annähernd und unverbindlich - Les mesures et poids sont approximatifs et sous réserve - Dimensions and weights are approximate and not binding

Pegoraro		Pegoraro		Pegoraro		Pegoraro	
PEG-07R re/dr/ri		PEG-08R re/dr/ri		PEG-09R re/dr/ri		PEG-10R re/dr/ri	
PEG-07L li/ga/le		PEG-08L li/ga/le		PEG-09L li/ga/le		PEG-10L li/ga/le	
Orig.-Nr. / réf. origine / orig.-part-no.		Orig.-Nr. / réf. origine / orig.-part-no.		Orig.-Nr. / réf. origine / orig.-part-no.		Orig.-Nr. / réf. origine / orig.-part-no.	
3300 re/dr/ri		2191 re/dr/ri		6729 re/dr/ri		1675 re/dr/ri	
3301 li/ga/le		2192 li/ga/le		6730 li/ga/le		1676 li/ga/le	
Gewicht / poids / weight		Gewicht / poids / weight		Gewicht / poids / weight		Gewicht / poids / weight	
0,810		0,900		0,320		1,450	
Schraube M12x1,25x35 - 12.9 boulon / bolt		Schraube M12x1,25x35 - 12.9 boulon / bolt		Schraube M10x1x35 - 10.9 boulon / bolt		Schraube M12x1,25x35 - 12.9 boulon / bolt	
30-1235		30-1235		30-1030		30-1235	

Pegoraro		Pegoraro		Pegoraro		Pegoraro	
PEG-11R re/dr/ri		PEG-15		PEG-28		PEG-38R re/dr/ri	
PEG-11L li/ga/le						PEG-38L li/ga/le	
Orig.-Nr. / réf. origine / orig.-part-no.		Orig.-Nr. / réf. origine / orig.-part-no.		Orig.-Nr. / réf. origine / orig.-part-no.		Orig.-Nr. / réf. origine / orig.-part-no.	
5378 re/dr/ri				8600			
5379 li/ga/le							
Gewicht / poids / weight		Gewicht / poids / weight		Gewicht / poids / weight		Gewicht / poids / weight	
1,280		0,920		0,840		0,240	
Schraube M14x1,5x40 - 12.9 boulon / bolt		Schraube M16x1,5x60 - 12.9 boulon / bolt		Schraube M16x1,5x60 - 12.9 boulon / bolt		Schraube M10x1x35 - 10.9 boulon / bolt	
30-1440		30-1660		30-1660		30-1030	

Pegoraro		Pegoraro		Perugini		Perugini	
PEG-47R re/dr/ri		RH86		CEL-07R re/dr/ri		MAS-03R re/dr/ri	
PEG-47L li/ga/le				CEL-07L li/ga/le		MAS-03L li/ga/le	
Orig.-Nr. / réf. origine / orig.-part-no.		Orig.-Nr. / réf. origine / orig.-part-no.		Orig.-Nr. / réf. origine / orig.-part-no.		Orig.-Nr. / réf. origine / orig.-part-no.	
		8590					
Gewicht / poids / weight		Gewicht / poids / weight		Gewicht / poids / weight		Gewicht / poids / weight	
0,220		1,050		0,980		1,300	
Schraube M8x1x30 - 10.9 boulon / bolt				Schraube M14x1,5x40 - 12.9 boulon / bolt		Schraube M14x1,5x40 - 12.9 boulon / bolt	
30-830				30-1440		30-1440	



Original Muzzi-Fräsmesser mit Garantie / couteaux Muzzi avec garantie / Original warranted Muzzi Blades

- Keine Original-Ersatzteile - Il ne s'agit pas de pièces originales - No genuine spare parts -

Perugini	
PAS-14R re/dr/ri	
PAS-14L li/ga/le NEU	
Orig.-Nr. / réf. origine / orig.-part-no.	
Gewicht / poids / weight 0,550	
Schraube M12x1,25x35 - 12.9 30-1235 boulon / bolt	

Perugini	
PRG-05R re/dr/ri	
PRG-05L li/ga/le	
Orig.-Nr. / réf. origine / orig.-part-no.	
Gewicht / poids / weight 1,060	

Rabe KG16	
RAB-03R re/dr/ri	
RAB-03L li/ga/le	
Orig.-Nr. / réf. origine / orig.-part-no.	
8415.14.01 re/dr/ri	
8415.14.02 li/ga/le	
Gewicht / poids / weight 1,190	

Rabe KG18	
RAB-04R re/dr/ri	
RAB-04L li/ga/le	
Orig.-Nr. / réf. origine / orig.-part-no.	
8415.42.01 re/dr/ri	
8415.42.02 li/ga/le	
Gewicht / poids / weight 1,210	

Rau	
RH551 re/dr/ri	
RH552 li/ga/le	
Orig.-Nr. / réf. origine / orig.-part-no.	
Gewicht / poids / weight 0,710	

Rau	
RH55	
Orig.-Nr. / réf. origine / orig.-part-no.	
E23374 (0023374)	
Gewicht / poids / weight 0,650	
Schraube M10x65 - 8.8 51-1065 boulon / bolt	

Rau	
RH55A	
Orig.-Nr. / réf. origine / orig.-part-no.	
Gewicht / poids / weight 0,820	

Rau	
RH74	
Orig.-Nr. / réf. origine / orig.-part-no.	
E35920 (0035920)	
Gewicht / poids / weight 0,870	

Rau	
RH90	
Orig.-Nr. / réf. origine / orig.-part-no.	
E35921 (0035921)	
Gewicht / poids / weight 0,900	

Rau	
RH90S	
Orig.-Nr. / réf. origine / orig.-part-no.	
Gewicht / poids / weight 0,900	

Rau	
RH110	
Orig.-Nr. / réf. origine / orig.-part-no.	
0049048	
Gewicht / poids / weight 1,130	

- Keine Original-Ersatzteile - Il ne s'agit pas de pièces originales - No genuine spare parts -

Maße und Gewichte annähernd und unverbindlich - Les mesures et poids sont approximatifs et sous réserve - Dimensions and weights are approximate and not binding
 Technische Änderungen vorbehalten - Modifications techniques réservées - Technical changes reserved



Original Muzzi-Fräsmesser mit Garantie / couteaux Muzzi avec garantie / Original warranted Muzzi Blades

Fräsmesser u. Rotorzinken nach Fabrikat:
 Couteaux et lames de rotalabour pour machines:
 Blades and knives for spike rotor to fit:

Technische Änderungen vorbehalten - Modifications techniques réservées - Technical changes reserved
 Maße und Gewichte annähernd und unverbindlich - Les mesures et poids sont approximatifs et sous réserve - Dimensions and weights are approximate and not binding

Renter L.M.T.		Renter L.M.T.		Renter L.M.T.		Renter L.M.T.	
REN-01R re/dr/ri		REN-02R re/dr/ri		REN-03R re/dr/ri		REN-04R re/dr/ri	
REN-01L li/ga/le		REN-02L li/ga/le		REN-03L li/ga/le		REN-04L li/ga/le	
Orig.-Nr. / réf. origine / orig.-part-no.		Orig.-Nr. / réf. origine / orig.-part-no.		Orig.-Nr. / réf. origine / orig.-part-no.		Orig.-Nr. / réf. origine / orig.-part-no.	
RTM-RTO		RTP-RTX		RL		RTG	
Gewicht / poids / weight		Gewicht / poids / weight		Gewicht / poids / weight		Gewicht / poids / weight	
0,800		0,910		0,630		1,200	
Schraube M14x1,5x40 - 12.9 boulon / bolt		Schraube M14x1,5x40 - 12.9 boulon / bolt		Schraube M12x1,25x35 - 12.9 boulon / bolt		Schraube M14x1,5x40 - 12.9 boulon / bolt	
30-1440		30-1440		30-1235		30-1440	

Rinieri	
RIN-01R re/dr/ri	
RIN-01L li/ga/le	
Orig.-Nr. / réf. origine / orig.-part-no.	
Gewicht / poids / weight	
0,420	

Rota Dairon	
ROS-01R re/dr/ri	
ROS-01L li/ga/le	
Orig.-Nr. / réf. origine / orig.-part-no.	
Gewicht / poids / weight	
0,890	

Rota Dairon	
ROT-26R re/dr/ri	
ROT-26L li/ga/le	
Orig.-Nr. / réf. origine / orig.-part-no.	
450.1003 re/dr/ri	
450.1004 li/ga/le	
Gewicht / poids / weight	
1,110	

Rota Dairon	
ROT-27R re/dr/ri	
ROT-27L li/ga/le	
Orig.-Nr. / réf. origine / orig.-part-no.	
450.1001 re/dr/ri	
450.1002 li/ga/le	
Gewicht / poids / weight	
0,520	

Rota Dairon	
ROT-28	
Orig.-Nr. / réf. origine / orig.-part-no.	
450.1005	
Gewicht / poids / weight	
0,780	

Roteco	
GRI-01R re/dr/ri	
GRI-01L li/ga/le	
Orig.-Nr. / réf. origine / orig.-part-no.	
60325110D	
Gewicht / poids / weight	
0,290	

Roteco	
FOR-08R re/dr/ri	
FOR-08L li/ga/le	
Orig.-Nr. / réf. origine / orig.-part-no.	
60327310-314MTZ	
Gewicht / poids / weight	
0,520	

Original Muzzi-Fräsmesser mit Garantie / couteaux Muzzi avec garantie / Original warranted Muzzi Blades

- Keine Original-Ersatzteile - Il ne s'agit pas de pièces originales - No genuine spare parts -

Fräsmesser u. Rotorzinken nach Fabrikat:
 Couteaux et lames de rotalabour pour machines:
 Blades and knives for spike rotor to fit:

Roteco

ROT-02R re/dr/ri	
ROT-02L li/ga/le	
Orig.-Nr. / réf. origine / orig.-part-no.	
T4	
Gewicht / poids / weight	0,450
Schraube M10x1x35 - 10.9 boulon / bolt	30-1035

Sandri

CEL-10R re/dr/ri	
CEL-10L li/ga/le	
Orig.-Nr. / réf. origine / orig.-part-no.	
T4	
Gewicht / poids / weight	1,230
Schraube M14x1,5x40 - 12.9 boulon / bolt	30-1440

Sandri

PAL-01R re/dr/ri	
PAL-01L li/ga/le	
Orig.-Nr. / réf. origine / orig.-part-no.	
Gewicht / poids / weight	0,710
Schraube M12x1,25x35 - 12.9 boulon / bolt	30-1235

Sandri

SAN-01R re/dr/ri	
SAN-01L li/ga/le	
Orig.-Nr. / réf. origine / orig.-part-no.	
T3	
Gewicht / poids / weight	0,940
Schraube M14x1,5x40 - 12.9 boulon / bolt	30-1440

Sauerburger

IND-23R re/dr/ri	
IND-23L li/ga/le	
Orig.-Nr. / réf. origine / orig.-part-no.	
3427 re/dr/ri	
3426 li/ga/le	
Gewicht / poids / weight	0,950

Schneider

AGR-23R re/dr/ri	
AGR-23L li/ga/le	
Orig.-Nr. / réf. origine / orig.-part-no.	
Gewicht / poids / weight	0,125

S.E.P.

BCS-01R re/dr/ri	
BCS-01L li/ga/le	
Orig.-Nr. / réf. origine / orig.-part-no.	
1000	
Gewicht / poids / weight	0,200
Schraube M8x1x30 - 10.9 boulon / bolt	30-830

S.E.P.

GRI-01R re/dr/ri	
GRI-01L li/ga/le	
Orig.-Nr. / réf. origine / orig.-part-no.	
1400-1700S	
Gewicht / poids / weight	0,290
Schraube M10x1x35 - 10.9 boulon / bolt	30-1035

S.E.P.

SEP-01R re/dr/ri	
SEP-01L li/ga/le	
Orig.-Nr. / réf. origine / orig.-part-no.	
35-40-50	
Gewicht / poids / weight	0,250
Schraube M8x1x30 - 10.9 boulon / bolt	30-830

S.E.P.

SEP-02R re/dr/ri	
SEP-02L li/ga/le	
Orig.-Nr. / réf. origine / orig.-part-no.	
207844 re/dr/ri	
207843 li/ga/le	
Gewicht / poids / weight	0,340
Schraube M10x1x35 - 10.9 boulon / bolt	30-1035

S.E.P.

SEP-03R re/dr/ri	
SEP-03L li/ga/le	
Orig.-Nr. / réf. origine / orig.-part-no.	
125-130	
Gewicht / poids / weight	0,450
Schraube M10x1x35 - 10.9 boulon / bolt	30-1035

S.E.P.

SEP-04R re/dr/ri	
SEP-04L li/ga/le	
Orig.-Nr. / réf. origine / orig.-part-no.	
115	
Gewicht / poids / weight	0,400
Schraube M10x1x35 - 10.9 boulon / bolt	30-1035

- Keine Original-Ersatzteile - Il ne s'agit pas de pièces originales - No genuine spare parts -

Maße und Gewichte annähernd und unverbindlich - Les mesures et poids sont approximatifs et sous réserve - Dimensions and weights are approximate and not binding - Technische Änderungen vorbehalten - Modifications techniques réservées - Technical changes reserved



Original Muzzi-Fräsmesser mit Garantie / couteaux Muzzi avec garantie / Original warranted Muzzi Blades

Fräsmesser u. Rotorzinken nach Fabrikat:
 Couteaux et lames de rotalabour pour machines:
 Blades and knives for spike rotor to fit:

Technische Änderungen vorbehalten - Modifications techniques réservées - Technical changes reserved
 Maße und Gewichte annähernd und unverbindlich - Les mesures et poids sont approximatifs et sous réserve - Dimensions and weights are approximate and not binding

S.E.P.		S.E.P.		S.E.P.		S.E.P.	
SEP-05R re/dr/ri		SEP-07R re/dr/ri		SEP-19R re/dr/ri		SEP-20R re/dr/ri	
SEP-05L li/ga/le		SEP-07L li/ga/le		SEP-19L li/ga/le		SEP-20L li/ga/le	
Orig.-Nr. / réf. origine / orig.-part-no.		Orig.-Nr. / réf. origine / orig.-part-no.		Orig.-Nr. / réf. origine / orig.-part-no.		Orig.-Nr. / réf. origine / orig.-part-no.	
140		1500-200REV		430/450		S/506-113	
Gewicht / poids / weight		Gewicht / poids / weight		Gewicht / poids / weight		Gewicht / poids / weight	
0,400		0,280		0,280		0,330	
Schraube M10x1x30 - 10.9 boulon / bolt		Schraube M10x1x30 - 10.9 boulon / bolt		Schraube M8x1x30 - 10.9 boulon / bolt		Schraube M10x1x35 - 10.9 boulon / bolt	
30-1030		30-1030		30-830		30-1035	

Sicma (Miglianico)		Sicma (Miglianico)		Sicma (Miglianico)		Sicma (Miglianico)	
MAS-45R re/dr/ri		SIM-01R re/dr/ri		SIM-02R re/dr/ri		SIM-04R re/dr/ri	
MAS-45L li/ga/le		SIM-01L li/ga/le		SIM-02L li/ga/le		SIM-04L li/ga/le	
Orig.-Nr. / réf. origine / orig.-part-no.		Orig.-Nr. / réf. origine / orig.-part-no.		Orig.-Nr. / réf. origine / orig.-part-no.		Orig.-Nr. / réf. origine / orig.-part-no.	
						4811281 re/dr/ri 4811282 li/ga/le	
Gewicht / poids / weight		Gewicht / poids / weight		Gewicht / poids / weight		Gewicht / poids / weight	
0,950		1,040		1,180		0,600	
Schraube M14x1,5x40 - 12.9 boulon / bolt		Schraube M14x1,5x40 - 12.9 boulon / bolt		Schraube M14x1,5x40 - 12.9 boulon / bolt		Schraube M12x1,25x35 - 12.9 boulon / bolt	
30-1440		30-1440		30-1440		30-1235	

Sicma (Miglianico)		Sicma (Miglianico)		Sicma (Miglianico)		Sicma (Miglianico)	
SIM-05R re/dr/ri		SIM-06R re/dr/ri		SIM-07R re/dr/ri		SIM-08R re/dr/ri	
SIM-05L li/ga/le		SIM-06L li/ga/le		SIM-07L li/ga/le		SIM-08L li/ga/le	
Orig.-Nr. / réf. origine / orig.-part-no.		Orig.-Nr. / réf. origine / orig.-part-no.		Orig.-Nr. / réf. origine / orig.-part-no.		Orig.-Nr. / réf. origine / orig.-part-no.	
4818223 re/dr/ri 4818222 li/ga/le		4818225 re/dr/ri 4818224 li/ga/le				4811281 re/dr/ri 4811282 li/ga/le	
Gewicht / poids / weight		Gewicht / poids / weight		Gewicht / poids / weight		Gewicht / poids / weight	
0,950		0,950		0,930		0,630	
Schraube M14x1,5x40 - 12.9 boulon / bolt		Schraube M14x1,5x40 - 12.9 boulon / bolt		Schraube M14x1,5x40 - 12.9 boulon / bolt		Schraube M12x1,25x35 - 12.9 boulon / bolt	
30-1440		30-1440		30-1440		30-1235	



Original Muzzi-Fräsmesser mit Garantie / couteaux Muzzi avec garantie / Original warranted Muzzi Blades

- Keine Original-Ersatzteile - Il ne s'agit pas de pièces originales - No genuine spare parts -

Sicma (Miglianico)

SIM-09R re/dr/ri	
SIM-09L li/ga/le	
Orig.-Nr. / réf. origine / orig.-part-no.	
4812426 re/dr/ri	
4812425 li/ga/le	
Gewicht / poids / weight	0,980
Schraube M14x1,5x40 - 12.9 boulon / bolt	30-1440

Sicma (Miglianico)

SIM-11R re/dr/ri	
SIM-11L li/ga/le	
Orig.-Nr. / réf. origine / orig.-part-no.	
4812426 re/dr/ri	
4812425 li/ga/le	
Gewicht / poids / weight	0,960
Schraube M14x1,5x40 - 12.9 boulon / bolt	30-1440

Sicma (Miglianico)

SIM-16R re/dr/ri	
SIM-16L li/ga/le	
Orig.-Nr. / réf. origine / orig.-part-no.	
4811400 re/dr/ri	
4811401 li/ga/le	
Gewicht / poids / weight	0,700
Schraube M12x1,25x35 - 12.9 boulon / bolt	30-1235

Sicma (Miglianico)

SIM-18R re/dr/ri	
SIM-18L li/ga/le	
Orig.-Nr. / réf. origine / orig.-part-no.	
4811400 re/dr/ri	
4811401 li/ga/le	
Gewicht / poids / weight	1,300
Schraube M14x1,5x40 - 12.9 boulon / bolt	30-1440

Sicma (Miglianico)

SIM-20R re/dr/ri	
SIM-20L li/ga/le	
Orig.-Nr. / réf. origine / orig.-part-no.	
4814782 re/dr/ri	
4814783 li/ga/le	
Gewicht / poids / weight	1,350
Schraube M14x1,5x40 - 12.9 boulon / bolt	30-1440

Sicma (Miglianico)

SIM-23R re/dr/ri	
SIM-23L li/ga/le	
Orig.-Nr. / réf. origine / orig.-part-no.	
4811403 re/dr/ri	
4811402 li/ga/le	
Gewicht / poids / weight	0,730
Schraube M12x1,25x35 - 12.9 boulon / bolt	30-1235

Sicma (Miglianico)

TOR-01R re/dr/ri	
TOR-01L li/ga/le	
Orig.-Nr. / réf. origine / orig.-part-no.	
4811400 re/dr/ri	
4811401 li/ga/le	
Gewicht / poids / weight	1,050
Schraube M12x1,25x35 - 12.9 boulon / bolt	30-1235

Simon

IND-06R re/dr/ri	
IND-06L li/ga/le	
Orig.-Nr. / réf. origine / orig.-part-no.	
4811400 re/dr/ri	
4811401 li/ga/le	
Gewicht / poids / weight	0,550
Schraube M10x1x35 - 10.9 boulon / bolt	30-1035

Simon

IND-10R re/dr/ri	
IND-10L li/ga/le	
Orig.-Nr. / réf. origine / orig.-part-no.	
4811400 re/dr/ri	
4811401 li/ga/le	
Gewicht / poids / weight	0,500
Schraube M10x1x35 - 10.9 boulon / bolt	30-1035

Simon

IND-20R re/dr/ri	
IND-20L li/ga/le	
Orig.-Nr. / réf. origine / orig.-part-no.	
4811400 re/dr/ri	
4811401 li/ga/le	
Gewicht / poids / weight	1,100
Schraube M14x1,5x40 - 12.9 boulon / bolt	30-1440

Simon

IND-74R re/dr/ri	
IND-74L li/ga/le	
Orig.-Nr. / réf. origine / orig.-part-no.	
4811400 re/dr/ri	
4811401 li/ga/le	
Gewicht / poids / weight	0,530
Schraube M10x1x35 - 10.9 boulon / bolt	30-1035

Simon

IND-482R re/dr/ri	
IND-482L li/ga/le	
Orig.-Nr. / réf. origine / orig.-part-no.	
4811400 re/dr/ri	
4811401 li/ga/le	
Gewicht / poids / weight	0,530
Schraube M10x1x35 - 10.9 boulon / bolt	30-1035

- Keine Original-Ersatzteile - Il ne s'agit pas de pièces originales - No genuine spare parts -

Maße und Gewichte annähernd und unverbindlich - Les mesures et poids sont approximatifs et sous réserve - Dimensions and weights are approximate and not binding - Technische Änderungen vorbehalten - Modifications techniques réservées - Technical changes reserved



Original Muzzi-Fräsmesser mit Garantie / couteaux Muzzi avec garantie / Original warranted Muzzi Blades

Fräsmesser u. Rotorzinken nach Fabrikat:
 Couteaux et lames de rotalabour pour machines:
 Blades and knives for spike rotor to fit:

Technische Änderungen vorbehalten - Modifications techniques réservées - Technical changes reserved
 Maße und Gewichte annähernd und unverbindlich - Les mesures et poids sont approximatifs et sous réserve - Dimensions and weights are approximate and not binding

Simon	
IND-483R re/dr/ri	
IND-483L li/ga/le	
Orig.-Nr. / réf. origine / orig.-part-no.	
Gewicht / poids / weight 0,450	

Simon	
IND-484R re/dr/ri	
IND-484L li/ga/le	
Orig.-Nr. / réf. origine / orig.-part-no.	
Gewicht / poids / weight 1,100	

Simon	
SIMO-03R re/dr/ri	
SIMO-03L li/ga/le	
Orig.-Nr. / réf. origine / orig.-part-no.	
Gewicht / poids / weight 0,530	

Simon	
SIMO-04R re/dr/ri	
SIMO-04L li/ga/le	
Orig.-Nr. / réf. origine / orig.-part-no.	
Gewicht / poids / weight 0,470	

Solo	
SOL-02R re/dr/ri	
SOL-02L li/ga/le	
Orig.-Nr. / réf. origine / orig.-part-no.	
5043162 re/dr/ri	
5043158 li/ga/le	
Gewicht / poids / weight 0,190	
Schraube M8x1x35 - 10.9 boulon / bolt	30-830

Solo	
SOL-03R re/dr/ri	
SOL-03L li/ga/le	
Orig.-Nr. / réf. origine / orig.-part-no.	
5043457 re/dr/ri	
5043456 li/ga/le	
Gewicht / poids / weight 0,200	
Schraube M8x1x35 - 10.9 boulon / bolt	30-830

Sovema	
MUR-06R re/dr/ri	
MUR-06L li/ga/le	
Orig.-Nr. / réf. origine / orig.-part-no.	
900111020 re/dr/ri	
900111019 li/ga/le	
Gewicht / poids / weight 0,650	
Schraube M12x1,25x35 - 12.9 boulon / bolt	30-1235

Sovema	
MUR-07R re/dr/ri	
MUR-07L li/ga/le	
Orig.-Nr. / réf. origine / orig.-part-no.	
900111014 re/dr/ri	
900111013 li/ga/le	
Gewicht / poids / weight 0,650	
Schraube M12x1,25x35 - 12.9 boulon / bolt	30-1235

Sovema	
SOV-02R re/dr/ri	
SOV-02L li/ga/le	
Orig.-Nr. / réf. origine / orig.-part-no.	
900111001 re/dr/ri	
900111002 li/ga/le	
Gewicht / poids / weight 0,800	
Schraube M12x1,25x40 - 12.9 boulon / bolt	30-1240

Sovema	
SOV-03R re/dr/ri	
SOV-03L li/ga/le	
Orig.-Nr. / réf. origine / orig.-part-no.	
900111003 re/dr/ri	
900111004 li/ga/le	
Gewicht / poids / weight 0,800	
Schraube M14x1,5x35 - 12.9 boulon / bolt	30-1435

Sovema	
SOV-04R re/dr/ri	
SOV-04L li/ga/le	
Orig.-Nr. / réf. origine / orig.-part-no.	
900111005 re/dr/ri	
900111006 li/ga/le	
Gewicht / poids / weight 1,050	
Schraube M14x1,5x40 - 12.9 boulon / bolt	30-1440

Sovema	
SOV-05R re/dr/ri	
SOV-05L li/ga/le	
Orig.-Nr. / réf. origine / orig.-part-no.	
900111007 re/dr/ri	
900111008 li/ga/le	
Gewicht / poids / weight 0,820	
Schraube M12x1,25x40 - 12.9 boulon / bolt	30-1240

Original Muzzi-Fräsmesser mit Garantie / couteaux Muzzi avec garantie / Original warranted Muzzi Blades

- Keine Original-Ersatzteile - Il ne s'agit pas de pièces originales - No genuine spare parts -

Fräsmesser u. Rotorzinken nach Fabrikat:
 Couteaux et lames de rotalabour pour machines:
 Blades and knives for spike rotor to fit:

Sovema	
SOV-06R re/dr/ri	
SOV-06L li/ga/le	
Orig.-Nr. / réf. origine / orig.-part-no.	
900111009 re/dr/ri	
900111010 li/ga/le	
Gewicht / poids / weight	0,800
Schraube M14x1,5x35 - 12.9 boulon / bolt	30-1435

Sovema	
SOV-08R re/dr/ri	
SOV-08L li/ga/le	
Orig.-Nr. / réf. origine / orig.-part-no.	
900111011 re/dr/ri	
900111012 li/ga/le	
Gewicht / poids / weight	1,180
Schraube M14x1,5x40 - 12.9 boulon / bolt	30-1440

Sovema	
SOV-11R re/dr/ri	
SOV-11L li/ga/le	
Orig.-Nr. / réf. origine / orig.-part-no.	
Gewicht / poids / weight	1,050
Schraube M14x1,5x40 - 12.9 boulon / bolt	30-1440

Sovema	
VAL-08R re/dr/ri	
VAL-08L li/ga/le	
Orig.-Nr. / réf. origine / orig.-part-no.	
900111021 re/dr/ri	
900111022 li/ga/le	
Gewicht / poids / weight	0,410

Tielbürger	
AGR-60R re/dr/ri	
AGR-60L li/ga/le	
Orig.-Nr. / réf. origine / orig.-part-no.	
KB-001-008 re/dr/ri	
KB-001-007 li/ga/le	
Gewicht / poids / weight	0,200

Tielbürger	
IND-125R re/dr/ri	
IND-125L li/ga/le	
Orig.-Nr. / réf. origine / orig.-part-no.	
KB-001-005 re/dr/ri	
KB-001-006 li/ga/le	
Gewicht / poids / weight	0,220

Tortella	
CEL-16R re/dr/ri	
CEL-16L li/ga/le	
Orig.-Nr. / réf. origine / orig.-part-no.	
Gewicht / poids / weight	0,950

Tortella	
TOR-01R re/dr/ri	
TOR-01L li/ga/le	
Orig.-Nr. / réf. origine / orig.-part-no.	
2915D re/dr/ri	
2915S li/ga/le	
Gewicht / poids / weight	1,150
Schraube M14x1,5x40 - 12.9 boulon / bolt	30-1440

Tortella	
TOR-05R re/dr/ri	
TOR-05L li/ga/le	
Orig.-Nr. / réf. origine / orig.-part-no.	
2985600 re/dr/ri	
2985602 li/ga/le	
Gewicht / poids / weight	0,940
Schraube M12x1,25x35 - 12.9 boulon / bolt	30-1235

Tortella	
TOR-06R re/dr/ri	
TOR-06L li/ga/le	
Orig.-Nr. / réf. origine / orig.-part-no.	
2985550 re/dr/ri	
2985552 li/ga/le	
Gewicht / poids / weight	0,610
Schraube M12x1,25x35 - 12.9 boulon / bolt	30-1235

Tortella	
TOR-07R re/dr/ri	
TOR-07L li/ga/le	
Orig.-Nr. / réf. origine / orig.-part-no.	
2985204 re/dr/ri	
2985206 li/ga/le	
Gewicht / poids / weight	1,140
Schraube M14x1,5x40 - 12.9 boulon / bolt	30-1440

Tortella	
TOR-10R re/dr/ri	
TOR-10L li/ga/le	
Orig.-Nr. / réf. origine / orig.-part-no.	
2985214 re/dr/ri	
2985216 li/ga/le	
Gewicht / poids / weight	1,240
Schraube M14x1,5x40 - 12.9 boulon / bolt	30-1440

- Keine Original-Ersatzteile - Il ne s'agit pas de pièces originales - No genuine spare parts -

Maße und Gewichte annähernd und unverbindlich - Les mesures et poids sont approximatifs et sous réserve - Dimensions and weights are approximate and not binding - Technische Änderungen vorbehalten - Modifications techniques réservées - Technical changes reserved



Original Muzzi-Fräsmesser mit Garantie / couteaux Muzzi avec garantie / Original warranted Muzzi Blades

Fräsmesser u. Rotorzinken nach Fabrikat:
 Couteaux et lames de rotalabour pour machines:
 Blades and knives for spike rotor to fit:

Technische Änderungen vorbehalten - Modifications techniques réservées - Technical changes reserved
 Maße und Gewichte annähernd und unverbindlich - Les mesures et poids sont approximatifs et sous réserve - Dimensions and weights are approximate and not binding

Tortella	
TOR-11R re/dr/ri	
TOR-11L li/ga/le	
Orig.-Nr. / réf. origine / orig.-part-no.	
2985554 re/dr/ri	
2985556 li/ga/le	
Gewicht / poids / weight	0,680
Schraube M12x1,25x35 - 12.9 boulon / bolt	30-1235

Tortella	
TOR-12R re/dr/ri	
TOR-12L li/ga/le	
Orig.-Nr. / réf. origine / orig.-part-no.	
2985604 re/dr/ri	
2985606 li/ga/le	
Gewicht / poids / weight	0,840
Schraube M12x1,25x35 - 12.9 boulon / bolt	30-1235

Tortella	
TOR-14R re/dr/ri	
TOR-14L li/ga/le	
Orig.-Nr. / réf. origine / orig.-part-no.	
2985608 re/dr/ri	
2985610 li/ga/le	
Gewicht / poids / weight	0,900
Schraube M14x1,5x40 - 12.9 boulon / bolt	30-1440

Tortella	
TOR-28R re/dr/ri	
TOR-28L li/ga/le	
Orig.-Nr. / réf. origine / orig.-part-no.	
Gewicht / poids / weight	1,300

Tortella	
TOR-29R re/dr/ri	
TOR-29L li/ga/le	
Orig.-Nr. / réf. origine / orig.-part-no.	
Gewicht / poids / weight	1,340

Tortella	
TOR-30R re/dr/ri	
TOR-30L li/ga/le	
Orig.-Nr. / réf. origine / orig.-part-no.	
Gewicht / poids / weight	1,960

Valpadana	
BRE-03R re/dr/ri	
BRE-03L li/ga/le	
Orig.-Nr. / réf. origine / orig.-part-no.	
4RM-300/400 450	
Gewicht / poids / weight	0,680
Schraube M12x1,25x35 - 12.9 boulon / bolt	30-1235

Valpadana	
BRU-05R re/dr/ri	
BRU-05L li/ga/le	
Orig.-Nr. / réf. origine / orig.-part-no.	
Gewicht / poids / weight	0,340

Valpadana	
SEP-03R re/dr/ri	
SEP-03L li/ga/le	
Orig.-Nr. / réf. origine / orig.-part-no.	
VMC150	
Gewicht / poids / weight	0,450
Schraube M10x1x35 - 10.9 boulon / bolt	30-1035

Valpadana	
SEP-07R re/dr/ri	
SEP-07L li/ga/le	
Orig.-Nr. / réf. origine / orig.-part-no.	
VMC130	
Gewicht / poids / weight	0,280
Schraube M10x1x30 - 10.9 boulon / bolt	30-1030

Valpadana	
VAL-04R re/dr/ri	
VAL-04L li/ga/le	
Orig.-Nr. / réf. origine / orig.-part-no.	
VMC15	
Gewicht / poids / weight	0,470
Schraube M10x1x30 - 10.9 boulon / bolt	30-1030

Valpadana	
VAL-05R re/dr/ri	
VAL-05L li/ga/le	
Orig.-Nr. / réf. origine / orig.-part-no.	
MC18-4RM20	
Gewicht / poids / weight	0,700
Schraube M10x1x35 - 10.9 boulon / bolt	30-1035

Original Muzzi-Fräsmesser mit Garantie / couteaux Muzzi avec garantie / Original warranted Muzzi Blades

- Keine Original-Ersatzteile - Il ne s'agit pas de pièces originales - No genuine spare parts -

Valpadana

VAL-06R re/dr/ri	
VAL-06L li/ga/le	
Orig.-Nr. / réf. origine / orig.-part-no. MC18-4RM20	
Gewicht / poids / weight	0,600
Schraube M10x1x35 - 10.9 boulon / bolt	30-1035

Valpadana

VAL-07R re/dr/ri	
VAL-07L li/ga/le	
Orig.-Nr. / réf. origine / orig.-part-no. VMC10-12	
Gewicht / poids / weight	0,340
Schraube M10x1x35 - 10.9 boulon / bolt	30-1035

Valpadana

VAL-08R re/dr/ri	
VAL-08L li/ga/le	
Orig.-Nr. / réf. origine / orig.-part-no. VMC14	
Gewicht / poids / weight	0,410
Schraube M10x1x35 - 10.9 boulon / bolt	30-1035

Valpadana

VAL-10R re/dr/ri	
VAL-10L li/ga/le	
Orig.-Nr. / réf. origine / orig.-part-no. VMC18	
Gewicht / poids / weight	0,640
Schraube M10x1x35 - 10.9 boulon / bolt	30-1035

Valpadana

VAL-11R re/dr/ri	
VAL-11L li/ga/le	
Orig.-Nr. / réf. origine / orig.-part-no. VMC8	
Gewicht / poids / weight	0,320
Schraube M10x1x35 - 10.9 boulon / bolt	30-1035

Valpadana

VAL-15R re/dr/ri	
VAL-15L li/ga/le	
Orig.-Nr. / réf. origine / orig.-part-no. 4RM-180	
Gewicht / poids / weight	0,560
Schraube M10x1x35 - 10.9 boulon / bolt	30-1035

Valpadana

VAL-19R re/dr/ri	
VAL-19L li/ga/le	
Orig.-Nr. / réf. origine / orig.-part-no.	
Gewicht / poids / weight	0,530

Vigolo

VIG-01R re/dr/ri	
VIG-01L li/ga/le	
Orig.-Nr. / réf. origine / orig.-part-no.	
Gewicht / poids / weight	1,000

VMC

VAL-20R re/dr/ri	
VAL-20L li/ga/le	
Orig.-Nr. / réf. origine / orig.-part-no.	
Gewicht / poids / weight	0,440

Yanmar

YAN-03R re/dr/ri	
YAN-03L li/ga/le	
Orig.-Nr. / réf. origine / orig.-part-no. 322-682-782	
Gewicht / poids / weight	0,400
Schraube M10x1x35 - 10.9 boulon / bolt	30-1035

Zappator

MAS-10R re/dr/ri	
MAS-10L li/ga/le	
Orig.-Nr. / réf. origine / orig.-part-no.	
Gewicht / poids / weight	0,850
Schraube M14x1,5x40 - 12.9 boulon / bolt	30-1440

Zappator

ZAP-06R re/dr/ri	
ZAP-06L li/ga/le	
Orig.-Nr. / réf. origine / orig.-part-no. Z2-Z3	
Gewicht / poids / weight	0,460
Schraube M10x1x35 - 10.9 boulon / bolt	30-1035

- Keine Original-Ersatzteile - Il ne s'agit pas de pièces originales - No genuine spare parts -

Maße und Gewichte annähernd und unverbindlich - Les mesures et poids sont approximatifs et sous réserve - Dimensions and weights are approximate and not binding - Technische Änderungen vorbehalten - Modifications techniques réservées - Technical changes reserved



Original Muzzi-Fräsmesser mit Garantie / couteaux Muzzi avec garantie / Original warranted Muzzi Blades

Technische Änderungen vorbehalten - Modifications techniques réservées - Technical changes reserved
Maße und Gewichte annähernd und unverbindlich - Les mesures et poids sont approximatifs et sous réserve - Dimensions and weights are approximate and not binding

BEN-49R re/dr/ri	
BEN-49L li/ga/le	
Orig.-Nr. / réf. origine / orig.-part-no.	
Gewicht / poids / weight 0,430	
Schraube M10x1x35 - 10.9 boulon / bolt	30-1035

BEN-50R re/dr/ri	
BEN-50L li/ga/le	
Orig.-Nr. / réf. origine / orig.-part-no.	
Gewicht / poids / weight 0,490	
Schraube M10x1x35 - 10.9 boulon / bolt	30-1035

BEN-51R re/dr/ri	
BEN-51L li/ga/le	
Orig.-Nr. / réf. origine / orig.-part-no.	
Gewicht / poids / weight 0,300	
Schraube M8x1x30 - 10.9 boulon / bolt	30-830

BEN-52R re/dr/ri	
BEN-52L li/ga/le	
Orig.-Nr. / réf. origine / orig.-part-no.	
Gewicht / poids / weight 0,350	
Schraube M10x1x35 - 10.9 boulon / bolt	30-1035

BRU-43R re/dr/ri	
BRU-43L li/ga/le	
Orig.-Nr. / réf. origine / orig.-part-no.	
Gewicht / poids / weight 0,450	
Schraube M10x1x35 - 10.9 boulon / bolt	30-1035

BRU-44R re/dr/ri	
BRU-44L li/ga/le	
Orig.-Nr. / réf. origine / orig.-part-no.	
Gewicht / poids / weight 0,410	
Schraube M10x1x35 - 10.9 boulon / bolt	30-1035

DIE-01R re/dr/ri	
DIE-01L li/ga/le	
Orig.-Nr. / réf. origine / orig.-part-no.	
Gewicht / poids / weight 0,330	
Schraube M8x1x35 - 10.9 boulon / bolt	30-830

DIE-02R re/dr/ri	
DIE-02L li/ga/le	
Orig.-Nr. / réf. origine / orig.-part-no.	
Gewicht / poids / weight 0,420	
Schraube M10x1x35 - 10.9 boulon / bolt	30-1035

DIE-03R re/dr/ri	
DIE-03L li/ga/le	
Orig.-Nr. / réf. origine / orig.-part-no.	
Gewicht / poids / weight 0,490	
Schraube M10x1x35 - 10.9 boulon / bolt	30-1035



Original Muzzi-Fräsmesser mit Garantie / couteaux Muzzi avec garantie / Original warranted Muzzi Blades

- Keine Original-Ersatzteile - Il ne s'agit pas de pièces originales - No genuine spare parts -

Schrauben mit Sicherungsmuttern
 boulons avec écrous à freinage interne
 bolts with self-locking nuts

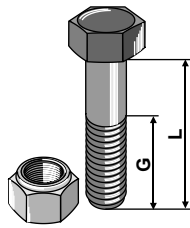

Best. Nr.: réf. article part-no.	Gewinde filet thread	Güte qualité quality	L	G	Gewicht poids weight
30-830	M8x1	10.9	30	19	0,021
30-1030	M10x1	10.9	30	17	0,039
30-1035	M10x1	10.9	35	20	0,043
30-1040	M10x1,5	10.9	40	30	0,047
30-1235	M12x1,25	12.9	35	22	0,064
30-1240	M12x1,25	12.9	40	27	0,068
30-1245	M12x1,25	12.9	45	22	0,072
30-1435	M14x1,5	12.9	35	18	0,092
30-1440	M14x1,5	12.9	40	26	0,099
30-1450	M14x1,5	12.9	50	34	0,109
30-1460	M14x1,5	12.9	60	25	0,121
30-1465	M14x1,5	12.9	65	37	0,126
30-1640	M16x1,5	12.9	40	20	0,135
30-1645	M16x1,5	12.9	45	22	0,142
30-1647	M16x1,5	12.9	47	25	0,146
30-1652	M16x1,5	12.9	52	25	0,149
30-1660	M16x1,5	12.9	60	40	0,159
30-1665	M16x1,5	12.9	65	39	0,176
63-TAA-91	1/2"UNF	12.9	43	22	0,070

Schrauben mit Muttern und Federringe
 boulons avec écrous et rondelles-ressort
 bolts with nuts and split washers

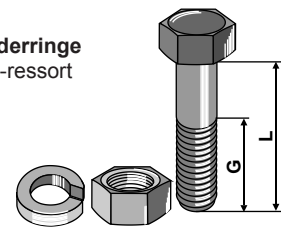

Best. Nr.: réf. article part-no.	Gewinde filet thread	Güte qualité quality	L	G	Gewicht poids weight
30-71632	7/16"UNF	12.9	32	20	0,054
30-71635	7/16"UNF	12.9	35	22	0,055
30-71640	7/16"UNF	12.9	40	24	0,060
30-3903	1/2"UNF	12.9	38	23	0,079
30-5844	5/8"UNF	12.9	45	26	0,154

- Keine Original-Ersatzteile - Il ne s'agit pas de pièces originales - No genuine spare parts -

Maße und Gewichte annähernd und unverbindlich - Les mesures et poids sont approximatifs et sous réserve - Dimensions and weights are approximate and not binding - Technische Änderungen vorbehalten - Modifications techniques réservées - Technical changes reserved

Federringe
 rondelles élastiques
 split washers

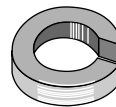

Best. Nr.: réf. article part-no.	Abmessung dimensions dimensions
30-U-7/16	7/16"
30-U-1/2	1/2"
30-U-5/8	5/8"

Dutzi

Innensechskantschrauben
 boulons à 6 pans creux
 hexagon socket bolts

Best. Nr.: réf. article part-no.	L	Güte qualité quality	Gewicht poids weight
51-1034	40	10.9	0,090
51-1023	55	12.9	0,110

Deckel
 chapeau / cap

51-1046

Rau

51-1065

Schraube für: RH55 / RH55A / RH74 / RH90 und RH90S
 boulon pour: RH55 / RH55A / RH74 / RH90 et RH90S
 bolt for: RH55 / RH55A / RH74 / RH90 and RH90S

Orig.-Nr.
 réf. origine / orig.-part-no.

0031301

Güte / qualité / quality	8,8
Gewicht / poids / weight	0,080

Sechskantmuttern
 écrous hexagonaux
 hexagon nuts

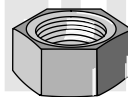

Best. Nr.: réf. article part-no.	Gewinde filet thread
30-MU8	M8
30-MU7/16	UNF 7/16"
30-MU1/2	UNF 1/2"
30-MU5/8	UNF 5/8"

Selbstsichernde Muttern
 écrous à freinage interne
 self-locking nuts

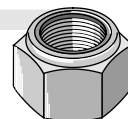

Best. Nr.: réf. article part-no.	Gewinde filet thread
30-MU10	M10x1
30-MU12	M12x1,25
30-MU12-3	M12x1,75
30-MU14	M14x1,5
30-MU16	M16x1,5
30-MU1/2.3	1/2"UNF